



2017

WINTER / SPRING

P R O M O P A C K



Special Offers for Milling, Turning, Drilling, and Solid Tooling Solutions...

MILLING SOLUTIONS

TURNING SOLUTIONS

DRILLING SOLUTIONS

SOLID ROUND SOLUTIONS

TOOL HOLDING SOLUTIONS



VALID THROUGH
June 30th, 2017

KPTI Company Overview

Established in April 2014, KPTI unifies two of the world's leading cutting tool manufacturers, Kyocera Tycom Corporation (KTC) and the Cutting Tool Division of Kyocera Industrial Ceramics Corporation (KICC-CT).

The new company creates a combined enterprise that optimizes the strengths of both organizations and facilitates expansion of Kyocera's overall cutting tool-related business in North America. The new combined entity will unify cutting tool resources to create greater efficiencies while positioning the new organization for continued success.

Customers will benefit from a unified sales and support team offering improved customer service and an expanded portfolio of cutting tool products and solutions for the automotive, aerospace, general machining, medical, power generation, printed circuit board and steel markets.

KPTI North American Operations

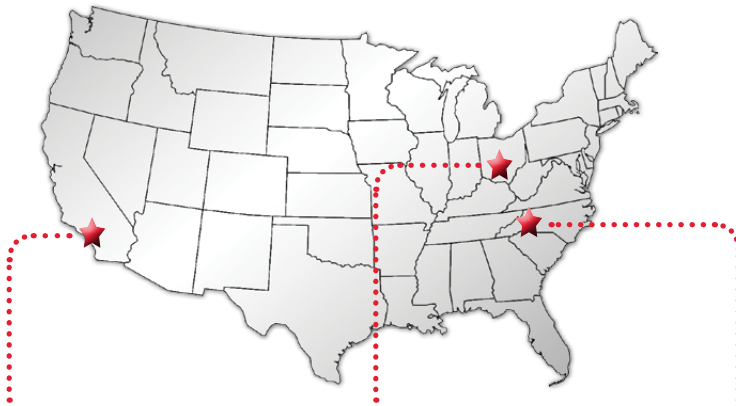

Costa Mesa, CA

Wapakoneta, OH

Hendersonville, NC



Administration & Manufacturing

- Administration & Accounting Center
- Micro-Tools Manufacturing
- Printed Circuit Board Drill Manufacturing
- Micro-Tools & PCB Sales & Customer Service Center

Steel Tool Holder Manufacturing

- Indexable Drills
- Milling End Mills & Face Mills
- Boring Bars
- Turning and Grooving Holders
- API Ring Groovers

KPTI North American HQ

- Indexable Insert Manufacturing
- North American Tech Center
- North American Sales, Marketing & Customer Service Center

KPTI

Manufactured Products



Steel Toolholders for Milling, Turning, Grooving, Threading and Drilling Metal



Indexable metal cutting inserts made of carbide, ceramic, cermet, Cubic Boron Nitride, and Polycrystalline diamond



Solid carbide cutting tools for tight tolerance and micro-diameter metal cutting applications

KPTI Markets Served



Automotive



Aerospace



Medical



Printed Circuit Board



Power Generation

Explore the Many Ways to Save with the Kyocera 2017 Winter / Spring Promo Pack

In 2017 Kyocera Precision Tools, Inc. is offering more ways to advance your productivity while also reducing your tooling costs. With our wide array of indexable and solid round cutting tools, we strive to be your primary source for high-quality, cost-effective solutions for all of your metal cutting needs. Read below for our latest cost-savings opportunities.

To learn more about KPTI, please visit www.kyoceraprecisiontools.com.

MILLING Solutions

MFH-Micro High Feed Mills	FREE Holder with Purchase of 10 Inserts per Pocket	P4
MFH-Mini High Feed Mills	FREE Holder with Purchase of 10 Inserts per Pocket	P6
MFH-RAPTOR High Feed Mills	FREE Holder with Purchase of 20 Inserts per Pocket	P8
M-FOUR (MEW) Four-Edge Mills	FREE Holder with Purchase of 10 Inserts per Pocket	P10
M-SIX (MFWN) Six-Edge Mills	FREE Holder with Purchase of 10 or 20 Inserts per Pocket	P12

TURNING Solutions

Cast Iron Turning with CA3-Series	Kits Include 1 Double-Clamp Holder and 10 Inserts	P14
Steel Turning with CA5-Series	Kits Include 1 Double-Clamp Holder and 10 Inserts	P16
Stainless Steel Turning with CA65-Series	Kits Include 1 Double-Clamp Holder and 10 Inserts	P18
Heat-Resistant Alloy Turning with PR1535 and PR13-Series	Kits Include 1 Double-Clamp Holder and 10 Inserts	P20

DRILLING Solutions

DRA Magic Drills	Kits Include 1 Drill Body and 2 Insert Tips	P22
	FREE Drill Body with Purchase of Designated Number of Inserts	P22
DRZ Magic Drills	Kits Include 1 Drill Body and 10 Inserts	P28
HOLESHOT Drills	Kits Include 1 Drill Body and 10 Inserts	P34

SOLID ROUND TOOLING SOLUTIONS

VULCAN Compression End Mills for Routing Composites	Buy 1, Get 1 50% Off (Equal or Lesser Value)	P42
---	---	---------------------

TOOL HOLDING SOLUTIONS

CAT40 / CAT50 Taper Adapters for End Mills and Face Mills	Discounted CAT40 & CAT50 Tool Holding Prices	P44
---	---	---------------------

How to Order

We sell our high-performance lineup of indexable and solid round cutting tools through our North American Distribution Partners. When placing an order for items in this Promo Pack, please reference the promo code provided.

To locate an Authorized Kyocera Distributor, please visit www.kyoceraprecisiontools.com/locate



NEW

MFH-RAPTOR MICRO

Smallest Diameter in High Feed Milling Series

Durable Design Aids in Chatter Resistance

Maximum D.O.C. 0.020" with stable high feed machining in a wide range of applications

Replaces Solid End Mills to Reduce Machining Costs

Suppresses chattering and increases milling efficiency

Advanced Coating Technology

MEGACOAT NANO Coating technology increases tool life when machining difficult-to-cut materials



Molded Convex Cutting Edge



High Precision G Class Insert

MILLING SOLUTIONS

TURNING SOLUTIONS

DRILLING SOLUTIONS

SOLID ROUND SOLUTIONS

TOOL HOLDING SOLUTIONS

1 Stable Machining with Chattering Resistance

Molded Convex Cutting Edge Controls Initial Impact when Entering the Workpiece

Cutting Force Comparison (In-house Evaluation)

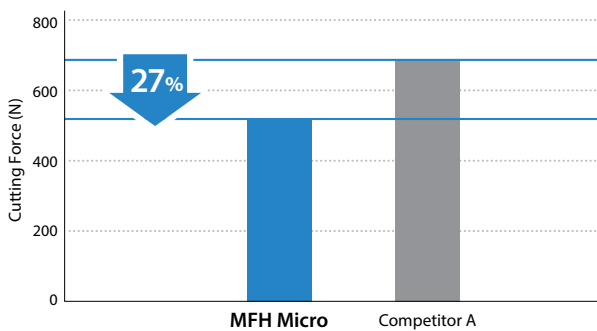

Cutting Conditions: $V_c = 390$ sfm, $f_z = 0.024$ ipt, D.O.C. = 0.016"
Cutter Dia. $\emptyset 0.375$ ", Slotting, Dry Workpiece: 1049

Increase in Cutting Force when Entering Work Piece (In-house Evaluation)

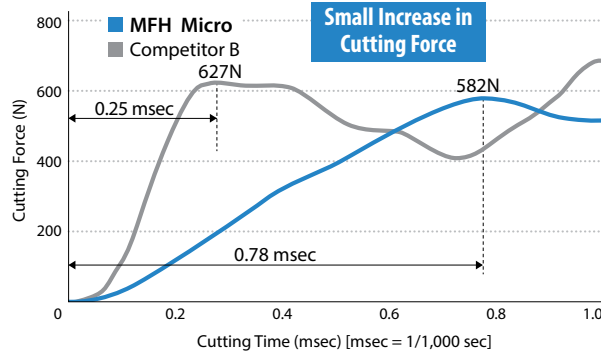

Cutting Conditions: $V_c = 390$ sfm, $f_z = 0.024$ ipt, D.O.C. $\times a_e = 0.016" \times 0.197"$
Cutter Dia. $\emptyset 0.375$ ", Dry Workpiece: 1049

2 Wide Range of Machining Applications

Wide Range of Machining Applications at a Maximum Depth of Cut of 0.020"

Stable Machining Even with Small Machining Centers

Cutting Performance Map (Cutter Dia. $\emptyset 0.375$ ")

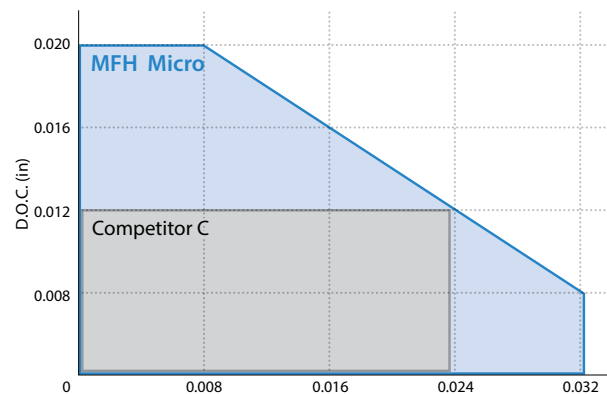

(In-house Evaluation)

All 2017 Winter / Spring Offers Valid through June 30, 2017

All promo items are available exclusively through Authorized North American Kyocera Precision Tool Distributors. Please use specified Promo Code when placing orders.

To locate a distributor visit www.kyoceraprecisiontools.com/locate. Prices Shown Valid in U.S. Only.

MEGACOAT NANO
PR1525

First Choice for Carbon Steel and Alloy Steel

MEGACOAT NANO
PR1535

First Choice for Titanium and Austenitic Stainless Steel

CVD Coated Carbide
CA6535

First Choice For Heat-Resistant Alloys and Martensitic Stainless Steel



FREE MFH-Micro End Mills

with Purchase of 10 Inserts per Pocket

Choose your Cutter and Grade
Promo Code: KYO-MICRO-FREE



Need a Taper Adapter?
See **Page 44-47** for
Discounted Selection

Cutter Description		Cutting Dia.	No. of Insert Pockets	Insert Description See Below	Grades (Pick 1)	Required Insert Purchase for FREE Cutter Body
Standard Shank (Cylindrical)	MFH 0500-S500-01-3T-3	0.500"	3	LPGT010210ER-GM	PR1525 Carbon Steel & Alloy Steel	30
	MFH 0625-S625-01-4T35	0.625"	4		PR1535 Titanium & Precipitation Hardened Stainless Steel CA6535 Heat-Resistant Alloys	40

*Offer also applies to metric-size cutters. View brochure for product details.

MFH-Raptor Micro Inserts

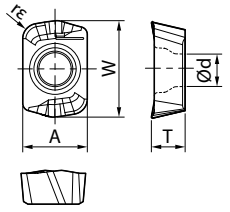
Usage Classification	P	Carbon Steel / Alloy Steel		★	★					
		Mold Steel								
★ Roughing / 1st Choice ☆ Roughing / 2nd Choice ■ Finishing / 1st Choice □ Finishing / 2nd Choice (When hardness is under 45HRC)	M	Austenitic Stainless Steel		★	☆					
		Martensitic Stainless Steel		☆	★					
	K	Gray Cast Iron								
		Ductile Cast Iron								
	S	Heat Resistant Alloy (Ni-base)		☆	★					
		Titanium Alloy (Ti-6Al-4V)		★						
H	Hard Materials									
Insert	Part Number	Dimensions (in)					MEGACOAT NANO		CVD Coating	
		A	T	Ød	W	τE	PR1535	PR1525	CA6535	
 General Purpose		LPGT 010210ER-GM	0.165	0.086	0.083	0.247	0.039	●	●	●

● : U.S. Stock



MFH-RAPTOR MINI

Small Diameter High Feed End Mills & Face Mills

Expanded Lineup

New MFH-Mini face mills now available in 1.500" and 2.000" diameters

Higher Productivity

Double-sided 4-edge inserts will save money and increase productivity

Advanced Coating Technology

MEGACOAT NANO Coating technology increases tool life when machining difficult-to-cut materials



MEGACOAT NANO
PR1525

First Choice for Carbon Steel and Alloy Steel

MEGACOAT NANO
PR1535

First Choice for Titanium and Austenitic Stainless Steel

CVD Coated Carbide
CA6535

First Choice For Heat-Resistant Alloys and Martensitic Stainless Steel



FREE MFH-Mini End Mills with Purchase of 10 Inserts per Pocket

Choose your Cutter and Grade
Promo Code: **KYO-MINI-FREE**



Need a Taper Adapter?
See **Page 44-47** for
Discounted Selection

Cutter Description		Cutting Dia.	No. of Insert Pockets	Insert Description See Page 7	Grades (Pick 1)	Required Insert Purchase for FREE Cutter Body
Weldon Shank	MFH 0625-W625-03-2T-3	0.625"	2	LOGU030310ER-GM	PR1525 Carbon Steel & Alloy Steel	20
	MFH 0750-W750-03-3T-4	0.750"	3			30
	MFH 1000-W100-03-4T47	1.000"	4			40
	MFH 1000-W100-03-5T47	1.000"	5			50
	MFH 1250-W125-03-5T-5	1.250"	5			50
	MFH 1250-W125-03-6T-5	1.250"	6			60
Long Shank	MFH 0625-S625-03-2T-6	0.625"	2		CA6535 Heat-Resistant Alloys	20
	MFH 0750-S750-03-3T65	0.750"	3			30
	MFH 1000-S100-03-4T-7	1.000"	4			40
	MFH 1250-S125-03-5T-8	1.250"	5			50

*Offer also applies to metric-size cutters. View brochure for product details.

All 2017 Winter / Spring Offers Valid through June 30, 2017

All promo items are available exclusively through Authorized North American Kyocera Precision Tool Distributors. Please use specified Promo Code when placing orders.

To locate a distributor visit www.kyoceraprecisiontools.com/locate. Prices Shown Valid in U.S. Only.



FREE MFH-Mini Face Mills with Purchase of 10 Inserts per Pocket

Choose your Cutter and Grade
Promo Code: KYO-MINI-FREE



Need a Taper Adapter?
See **Page 44-47** for
Discounted Selection

Cutter Description	Cutting Dia.	No. of Insert Pockets	Insert Description See Below	Grades (Pick 1)	Required Insert Purchase for FREE Cutter Body
MFH 1500R-03-5T	1.500"	5	LOGU030310ER-GM	PR1525 Carbon Steel & Alloy Steel	50
MFH 1500R-03-6T	1.500"	6		PR1535 Titanium & Precipitation Hardened Stainless Steel	60
MFH 2000R-03-8T	2.000"	8		CA6535 Heat-Resistant Alloys	80

*Offer also applies to metric-size cutters. View brochure for product details.

MFH-Raptor Mini Inserts

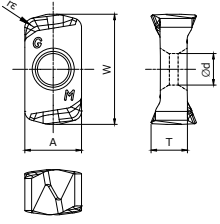
Usage Classification	P	Carbon Steel / Alloy Steel		★	★					
		Mold Steel								
★ Roughing / 1st Choice ☆ Roughing / 2nd Choice ■ Finishing / 1st Choice □ Finishing / 2nd Choice (When hardness is under 45HRC)	M	Austenitic Stainless Steel		★	☆					
		Martensitic Stainless Steel		☆	★					
	K	Gray Cast Iron								
		Ductile Cast Iron								
	S	Heat Resistant Alloy (Ni-base)		☆	★					
		Titanium Alloy (Ti-6Al-4V)		★						
H	Hard Materials									
Insert	Part Number	Dimensions (in)					MEGACOAT NANO		CVD Coating	
		A	T	Ød	W	rε	PR1535	PR1525	CA6535	
 General Purpose		LOGU 030310ER-GM	0.244	0.156	0.136	0.469	0.039	●	●	●

● : U.S. Stock



MFH-RAPTOR

Anti-Vibration Design for High Feed Milling Applications

High Feed with Less Vibration

Offering a variety of options with 3 different insert designs

Higher Productivity

Available for ramping and helical milling

Advanced Coating Technology

MEGACOAT NANO Coating technology increases tool life when machining difficult-to-cut materials



MEGACOAT NANO
PR1525

First Choice for Carbon Steel and Alloy Steel

MEGACOAT NANO
PR1535

First Choice for Titanium and Austenitic Stainless Steel

CVD Coated Carbide
CA6535

First Choice For Heat-Resistant Alloys and Martensitic Stainless Steel



FREE MFH Face Mills with Purchase of 20 Inserts per Pocket

Choose your Cutter, Chipbreaker, and Grade
Promo Code: **KYO-MFH-FREE**



Need a Taper Adapter?
See **Page 44-47** for
Discounted Selection

Cutter Description		Cutting Dia.	No. of Insert Pockets	Insert Description See Page 9	Chipbreaker (Pick 1)	Grades (Pick 1)	Required Insert Purchase for FREE Cutter Body
Face Mills	MFH 2000R-10-4T	2.000"	4	SOMT100420ER	GM General Purpose LD Large Depths of Cut FL Full Profile	PR1525 Carbon Steel & Alloy Steel	80
	MFH 2000R-10-5T	2.000"	5				100
	MFH 2500R-10-5T	2.500"	5				100
	MFH 2500R-10-6T	2.500"	6				120
	MFH 3000R-10-7T	3.000"	7				140
	MFH 2000R-14-4T	2.000"	4				SOMT140520ER SOMT140514ER
	MFH 2500R-14-4T	2.500"	4	80			
	MFH 2500R-14-5T	2.500"	5	100			
	MFH 3000R-14-5T	3.000"	5	100			
	MFH 3000R-14-6T	3.000"	6	120			
	MFH 4000R-14-6T	4.000"	6	120			
	MFH 4000R-14-7T	4.000"	7	140			
	MFH 5000R-14-7T	5.000"	7	140			
	MFH 6000R-14-8T	6.000"	8	160			

*Offer also applies to metric-size cutters. View brochure for product details.

All 2017 Winter / Spring Offers Valid through June 30, 2017

All promo items are available exclusively through Authorized North American Kyocera Precision Tool Distributors. Please use specified Promo Code when placing orders.
To locate a distributor visit www.kyoceraprecisiontools.com/locate. Prices Shown Valid in U.S. Only.

MILLING SOLUTIONS

TURNING SOLUTIONS

DRILLING SOLUTIONS

SOLID ROUND SOLUTIONS

TOOL HOLDING SOLUTIONS



FREE MFH End Mills with Purchase of 20 Inserts per Pocket

Choose your Cutter, Chipbreaker, and Grade
Promo Code: KYO-MFH-FREE



Need a Taper Adapter?
See **Page 44-47** for
Discounted Selection

Cutter Description		Cutting Dia.	No. of Insert Pockets	Insert Description See Below	Chipbreaker (Pick 1)	Grades (Pick 1)	Required Insert Purchase for FREE Cutter Body			
End Mills Standard Shank (Weldon)	MFH 1000-W100-10-2T	1.000"	2	SOMT100420ER	GM General Purpose	PR1525 Carbon Steel & Alloy Steel	40			
	MFH 1250-W125-10-2T	1.250"	2				40			
	MFH 1250-W125-10-3T	1.250"	3				60			
	MFH 1500-W150-10-3T	1.500"	3				60			
	MFH 1500-W150-10-4T	1.500"	4				80			
End Mills Long Shank (Cylindrical)	MFH 1000-S100-10-2T-8	1.000"	2				SOMT100420ER	LD Large Depths of Cut	PR1535 Titanium & Precipitation Hardened Stainless Steel	40
	MFH 1250-S125-10-2T-8	1.250"	2							40
	MFH 1500-S125-10-4T-10	1.500"	4							80
End Mills Long Shank (Cylindrical)	MFH 1000-S100-10-2T-8	1.000"	2	SOMT100420ER	FL Full Profile	CA6535 Heat-Resistant Alloys				40
	MFH 1250-S125-10-2T-8	1.250"	2							40
	MFH 1500-S125-10-4T-10	1.500"	4							80

*Offer also applies to metric-size cutters. View brochure for product details.

MFH-Raptor Inserts

Usage Classification	P	Carbon Steel / Alloy Steel		M	Austenitic Stainless Steel		K	Gray Cast Iron		S	Heat Resistant Alloy (Ni-base)		H	Titanium Alloy (Ti-6Al-4V)		Hard Materials	
		★	★		★	☆		★	☆		★	★					
★ Roughing / 1st Choice ☆ Roughing / 2nd Choice ■ Finishing / 1st Choice □ Finishing / 2nd Choice (When hardness is under 45HRC)	M	Austenitic Stainless Steel		★	☆												
		Martensitic Stainless Steel		☆													
	K	Gray Cast Iron															
		Ductile Cast Iron															
	S	Heat Resistant Alloy (Ni-base)		☆													
		Titanium Alloy (Ti-6Al-4V)		★													
H	Hard Materials																
Insert	Part Number	Dimensions (in)					Angle	MEGACOAT NANO		CVD Coating							
		A	T	Ød	Z	re		α	PR1535		PR1525	CA6535					
 General Purpose		SOMT 100420ER-GM	0.406	0.180	0.181	-	0.079	16°	●	●	●						
		SOMT 140520ER-GM	0.557	0.219	0.228	-	0.079	16°	●	●	●						
 Large D.O.C.		SOMT 100420ER-LD	0.411	0.180	0.181	0.035	0.079	16°	●	●	●						
		SOMT 140520ER-LD	0.581	0.219	0.228	0.063	0.079	16°	●	●	●						
 Wiper Edge		SOMT 100420ER-FL	0.411	0.180	0.181	0.055	0.079	16°	●	●	●						
		SOMT 140514ER-FL	0.574	0.219	0.228	0.122	0.055	16°	●	●							

● : U.S. Stock

KYOCERA Precision Tools, Inc.

P: 800.823.7284 • F: 828.692.1344 • E: ctsales@kyocera.com
Official Website | www.kyoceraprecisiontools.com

MILLING SOLUTIONS

TURNING SOLUTIONS

DRILLING SOLUTIONS

SOLID ROUND SOLUTIONS

TOOL HOLDING SOLUTIONS



M-FOUR (MEW)

Double-Sided 4-Edge Insert Face Mills & End Mills

Low Cutting Forces

Reduces cutting forces for reduced vibration

Improved Surface Finish

Sharp cutting for reduced burrs due to helical cutting edge and optimum axial rake design

Advanced Coating Technology

MEGACOAT NANO Coating technology increases tool life when machining difficult-to-cut materials



MEGACOAT NANO
PR1535

First Choice for Titanium and Austenitic Stainless Steel

MEGACOAT NANO
PR1525

First Choice for Carbon Steel and Alloy Steel

MEGACOAT NANO
PR1510

First Choice for Gray & Nodular Cast Iron

CVD Coated Carbide
CA6535

First Choice For Heat-Resistant Alloys and Martensitic Stainless Steel

DLC Coated / Uncoated Carbide
PDL025 / GW25

First Choice for Aluminum & Non-ferrous Metals



FREE M-FOUR (MEW) End Mills

with Purchase of 10 Inserts per Pocket

Choose your Cutter, Chipbreaker, and Grade
Promo Code: KYO-MEW-FREE



Need a Taper Adapter?
See **Page 44-47** for
Discounted Selection

Cutter Description		Cutting Dia.	No. of Insert Pockets	Insert Description See Page 11	Chipbreaker (Pick 1)	Grades (Pick 1)	Required Insert Purchase for FREE Cutter Body
Weldon	Standard Shank	MEW 0625-W500-10-2T	0.625"	2	LOMU1004..ER LOGT100408FR	GM General Purpose SM Low Cutting Force GH Heavy Milling AM Aluminum / Non-ferrous Metals (2-edge)	20
		MEW 0625-W625-10-2T	0.625"	2			20
		MEW 0750-W625-10-2T	0.750"	2			20
		MEW 0750-W750-10-2T	0.750	2			20
		MEW 0750-W750-10-3T	0.750	3			30
		MEW 0750-W750-4-10-3T	0.750	3			30
		MEW 1000-W750-10-3T	1.000	3			30
	MEW 1000-W100-10-2T	1.000	2	20			
	MEW 1000-W100-10-3T	1.000	3	30			
	MEW 1000-W100-475-10-3T	1.000	3	30			
	MEW 1250-W100-10-4T	1.250	4	40			
	MEW 1250-W125-10-3T	1.250	3	30			
	MEW 1250-W125-10-4T	1.250	4	40			
	MEW 1500-W125-10-5T	1.500	5	50			
Cylindrical	Long Shank	MEW 0750-W750-4-10-3T	0.750	3	30	PR1535 Titanium & Precipitation Hardened Stainless Steel PR1525 Carbon Steel & Alloy Steel PR1510 Gray & Nodular Cast Iron	30
		MEW 1000-W100-45-10-3T	1.000	3	30		
		MEW 0625-S625-6-10-2T	0.625	2	20		
		MEW 0750-S750-7-10-2T	0.750	2	20		
		MEW 1000-S100-7-10-3T	1.000	3	30		
		MEW 1000-S100-8-10-2T	1.000	2	20		
		MEW 1000-S100-8-10-3T	1.000	3	30		
Weldon	Standard Shank	MEW 1250-S125-8-15-3T	1.250	3	30	CA6535 Heat-Resistant Alloys PDL025 / GW25 Aluminum / Non-ferrous Metals	30
		MEW 1500-S125-8-15-4T	1.500	4	40		
		MEW 1000-W750-15-2T	1.000	2	20		
		MEW 1000-W100-15-2T	1.000	2	20		
		MEW 1250-W100-15-2T	1.250	2	20		
		MEW 1250-W125-15-2T	1.250	2	20		
		MEW 1250-W125-15-3T	1.250	3	30		
		MEW 1500-W125-15-3T	1.500	3	30		
		MEW 1500-W125-15-4T	1.500	4	40		
		MEW 1000-W750-15-2T	1.000	2	20		
MEW 1000-W100-15-2T	1.000	2	20				

*Offer also applies to metric-size cutters. View brochure for product details.

All 2017 Winter / Spring Offers Valid through June 30, 2017

All promo items are available exclusively through Authorized North American Kyocera Precision Tool Distributors. Please use specified Promo Code when placing orders.

To locate a distributor visit www.kyoceraprecisiontools.com/locate. Prices Shown Valid in U.S. Only.

MILLING SOLUTIONS

TURNING SOLUTIONS

DRILLING SOLUTIONS

SOLID ROUND SOLUTIONS

TOOL HOLDING SOLUTIONS



FREE M-FOUR (MEW) Face Mills with Purchase of 10 Inserts per Pocket

Choose your Cutter, Chipbreaker, and Grade
Promo Code: KYO-MEW-FREE



Need a Taper Adapter?
See Page 44-47 for
Discounted Selection

Cutter Description		Cutting Dia.	No. of Insert Pockets	Insert Description See Below	Chipbreaker (Pick 1)	Grades (Pick 1)	Required Insert Purchase for FREE Cutter Body
Face Mills	MEW 1500R-10-ST	1.500"	5	LOMU1004..ER LOGT100408FR	GM General Purpose SM Low Cutting Force GH Heavy Milling AM Aluminum / Non-ferrous metals (2-edge)	PR1535 Titanium & Precipitation Hardened Stainless Steel	50
	MEW 2000R-10-ST	2.000"	5			PR1525 Carbon Steel & Alloy Steel	60
	MEW 2500R-10-6T	2.500"	6			PR1510 Gray & Nodular Cast Iron	40
	MEW 2000R-15-4T	2.000"	4			CA6535 Heat-Resistant Alloys	50
	MEW 2000R-15-5T	2.000"	5	LOMU1505..ER LOGT150508FR		PDL025 / GW25 Aluminum / Non-ferrous Metals	60
	MEW 2500R-15-5T	2.500"	5			80	
	MEW 3000R-15-6T	3.000"	6				
	MEW 4000R-15-8T	4.000"	8				

*Offer also applies to metric-size cutters. View brochure for product details.

M-FOUR (MEW) Inserts

Usage Classification	P	Carbon Steel / Alloy Steel		M	Austenitic Stainless Steel		K	Gray Cast Iron		N	Non-ferrous Metals		S	Heat Resistant Alloy (Ni-base)		H	Hard Materials	
		★	☆		★	☆		★	☆		★	☆		★	☆		★	☆
★ Roughing / 1st Choice ☆ Roughing / 2nd Choice ■ Finishing / 1st Choice □ Finishing / 2nd Choice (When hardness is under 45HRC)	Mold Steel			Precipitation Hardened Stainless Steel			Ductile Cast Iron			Non-ferrous Metals			Titanium Alloy (Ti-6Al-4V)			Hard Materials		
	General Purpose	LOMU	100404ER-GM	Dimensions (in)					Angle	MEGACOAT NANO			CVD Coating	DLC Coated Carbide	Carbide			
				A	T	Ød	W	Z		re	α	PR1535	PR1525	PR1510	CA6535	PDL025	GW25	
	Low Cutting Force	LOMU	100408ER-SM	Dimensions (in)					Angle	MEGACOAT NANO			CVD Coating	DLC Coated Carbide	Carbide			
				A	T	Ød	W	Z		re	α	PR1535	PR1525	PR1510	CA6535	PDL025	GW25	
	Tough Edge (Heavy Milling)	LOMU	100408ER-GH	Dimensions (in)					Angle	MEGACOAT NANO			CVD Coating	DLC Coated Carbide	Carbide			
				A	T	Ød	W	Z		re	α	PR1535	PR1525	PR1510	CA6535	PDL025	GW25	
	Aluminum / Non-ferrous Metals (2-edge)	LOGT	100408FR-AM	Dimensions (in)					Angle	MEGACOAT NANO			CVD Coating	DLC Coated Carbide	Carbide			
				A	T	Ød	W	Z		re	α	PR1535	PR1525	PR1510	CA6535	PDL025	GW25	

● : U.S. Stock

KYOCERA Precision Tools, Inc.

P: 800.823.7284 • F: 828.692.1344 • E: ctsales@kyocera.com
Official Website | www.kyoceraprecisiontools.com

MILLING SOLUTIONS

TURNING SOLUTIONS

DRILLING SOLUTIONS

SOLID ROUND SOLUTIONS

TOOL HOLDING SOLUTIONS



M-SIX (MFWN)

Double-Sided 6-Edge Insert Face Mills & End Mills

Low Cutting Forces

Sharp cutting with lower cutting forces due to steep rake angle

Superior Fracture Resistance

Thick edge and stable clamping due to unique insert face design

Advanced Coating Technology

MEGACOAT NANO Coating technology increases tool life when machining difficult-to-cut materials



MEGACOAT NANO
PR1535

First Choice for Titanium and Austenitic Stainless Steel

MEGACOAT NANO
PR1525

First Choice for Carbon Steel and Alloy Steel

MEGACOAT NANO
PR1510

First Choice for Gray & Nodular Cast Iron

DLC Coated / Uncoated Carbide
PDL025 / GW25

First Choice for Aluminum & Non-ferrous Metals



FREE M-SIX (MFWN) Face Mills

with Purchase of Designated Number of Inserts per Pocket

Choose your Cutter, Chipbreaker, and Grade

Promo Code: **KYO-MFWN-FREE**



Need a Taper Adapter?
See **Page 44-47** for Discounted Selection

Cutter Description		Cutting Dia.	No. of Insert Pockets	Insert Description See ☺ Page 13	Chipbreaker (Pick 1)	Grades (Pick 1)	Required Insert Purchase for FREE Cutter Body	
Coarse Pitch	MFWN 902500R-3T	2.500"	3	WNMU080604EN WNMU080608EN WNEU080608EN* WNGT080608FN*	GM General Purpose SM Low Cutting Force GH* Heavy Milling GL* Surface Finish AM* Aluminum / Non-ferrous Metals (3-edge)	PR1535 Titanium & Precipitation Hardened Stainless Steel PR1525 Carbon Steel & Alloy Steel PR1510 Gray & Nodular Cast Iron PDL025 / GW25 Aluminum / Non-ferrous Metals	60	
	MFWN 903000R-4T	3.000"	4				80	
	MFWN 904000R-5T	4.000"	5				100	
	MFWN 905000R-6T	5.000"	6				120	
	MFWN 906000R-8T	6.000"	8				160	
	MFWN 908000R-10T	8.000"	10				200	
	MFWN 9010000R-12T	10.000"	12				240	
Fine Pitch	NEW MFWN 902000R-4T	2.000"	4				80	
	MFWN 902500R-4T	2.500"	4				80	
	MFWN 903000R-5T	3.000"	5				100	
	MFWN 904000R-7T	4.000"	7				140	
	MFWN 905000R-8T	5.000"	8				160	
	MFWN 906000R-10T	6.000"	10				200	
	MFWN 908000R-12T	8.000"	12				240	
	MFWN 9010000R-14T	10.000"	14				280	
	Extra-Fine Pitch	MFWN 902500R-5T	2.500"				5	50
		MFWN 903000R-7T	3.000"				7	70
MFWN 904000R-9T		4.000"	9				90	
MFWN 905000R-12T		5.000"	12				120	
MFWN 906000R-14T		6.000"	14				140	
MFWN 908000R-16T		8.000"	16				160	
MFWN 9010000R-18T		10.000"	18	180				

*GL Chipbreaker is only available with WNEU080608EN insert.

*GH Chipbreaker is not available in grade PR1535. *GH Chipbreaker is not recommended for extra-fine pitch face mills.

*AM Chipbreaker and grades PDL025 & GW25 are only available with WNGT080608FN insert.

*Offer also applies to metric-size cutters. View brochure for product details.

All 2017 Winter / Spring Offers Valid through June 30, 2017

All promo items are available exclusively through Authorized North American Kyocera Precision Tool Distributors. Please use specified Promo Code when placing orders.

To locate a distributor visit www.kyoceraprecisiontools.com/locate. Prices Shown Valid in U.S. Only.

MILLING SOLUTIONS

TURNING SOLUTIONS

DRILLING SOLUTIONS

SOLID ROUND SOLUTIONS

TOOL HOLDING SOLUTIONS



FREE M-SIX (MFWN) End Mills with Purchase of 10 Inserts per Pocket

Choose your Cutter, Chipbreaker, and Grade
Promo Code: KYO-MFWN-FREE



Need a Taper Adapter?
See **Page 44-47** for
Discounted Selection

Cutter Description		Cutting Dia.	No. of Insert Pockets	Insert Description See Below	Chipbreaker (Pick 1)	Grades (Pick 1)	Required Insert Purchase for FREE Cutter Body
End Mills	MFWN 902000R-W125-3T	2.000"	3	WNMU080604EN WNMU080608EN WNEU080608EN* WNGT080608FN*	GM General Purpose	PR1535 Titanium & Precipitation Hardened Stainless Steel PR1525 Carbon Steel & Alloy Steel PR1510 Gray & Nodular Cast Iron PDL025 / GW25 Aluminum / Non-ferrous Metals	30
	MFWN 902500R-W125-4T	2.500"	4		SM Low Cutting Force GH* Heavy Milling GL* Surface Finish AM* Aluminum / Non-ferrous Metals (3-edge)		40
	MFWN 903000R-W125-5T	3.000"	5				50

*GL Chipbreaker is only available with **WNEU080608EN** insert.

*GH Chipbreaker is not available in grade **PR1535**. *GH Chipbreaker is not recommended for extra-fine pitch face mills.

*AM Chipbreaker and grades **PDL025** & **GW25** are only available with **WNGT080608FN** insert.

*Offer also applies to metric-size cutters. View brochure for product details.

M-SIX (MFWN) Inserts

Usage Classification	P	Carbon Steel / Alloy Steel		★	★			
		Mold Steel						
★ Roughing / 1st Choice ☆ Roughing / 2nd Choice ■ Finishing / 1st Choice □ Finishing / 2nd Choice (When hardness is under 45HRC)	M	Austenitic Stainless Steel		★	☆			
		Martensitic Stainless Steel		☆				
	Precipitation Hardened Stainless Steel		★					
	K	Gray Cast Iron				★		
		Ductile Cast Iron				★		
	N	Non-ferrous Metals					★	☆
Heat Resistant Alloy (Ni-base)			☆					
S	Titanium Alloy (Ti-6Al-4V)			★				
	Hard Materials				□			
Insert	Part Number	Dimensions (in)		MEGACOAT NANO			DLC Coated Carbide	Carbide
		Z	re	PR1535	PR1525	PR1510	PDL025	GW25
 General Purpose	WNMU 080604EN-GM	0.067	1/64	●	●	●		
	080608EN-GM	0.051	1/32	●	●	●		
 Low Cutting Force	WNMU 080608EN-SM	0.051	1/32	●	●	●		
 Tough Edge (Heavy Milling)	WNMU 080608EN-GH	0.051	1/32		●	●		
 Surface Finish Oriented Ground Tolerance	WNEU 080608EN-GL	0.059	1/32	●	●	●		
 Aluminum / Non-ferrous Metals (3-edge)	WNGT 080608FN-AM	0.061	1/32				●	●

KYOCERA Precision Tools, Inc.

● : U.S. Stock

P: 800.823.7284 • F: 828.692.1344 • E: ctsales@kyocera.com
 Official Website | www.kyoceraprecisiontools.com

MILLING SOLUTIONS

TURNING SOLUTIONS

DRILLING SOLUTIONS

SOLID ROUND SOLUTIONS

TOOL HOLDING SOLUTIONS



Cast Iron Turning Kits

CA3-Series Inserts and Double-Clamp Holders

CA3 for cast iron machining with new K-series chipbreakers great for a large range of heavy machining operations due to improved chipping resistance.



MILLING SOLUTIONS

TURNING SOLUTIONS

DRILLING SOLUTIONS

SOLID ROUND SOLUTIONS

TOOL HOLDING SOLUTIONS

CAST IRON TURNING KITS (1 Double-Clamp Holder & 10 Inserts)

Promo Code: **KYO-CA3-KIT**

New Coated Carbide Grades CA3-Series for Reliable & Efficient Cast Iron Turning

Improved Coating Adhesion Prevents Chipping and Provides Stable Machining

CA310 for High-Speed Continuous Machining

Focused on wear resistance for machining gray cast iron through the deposition of a thickened alumina coating layer

Gray Cast Iron **1st Recommendation CA310**

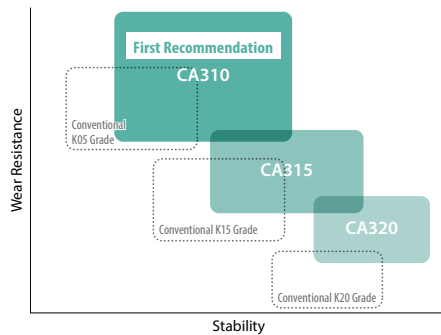

CA315 for General Machining

Excellent performance for machining gray & nodular cast iron by optimizing the total coating layer thickness

Nodular Cast Iron **1st Recommendation CA315**

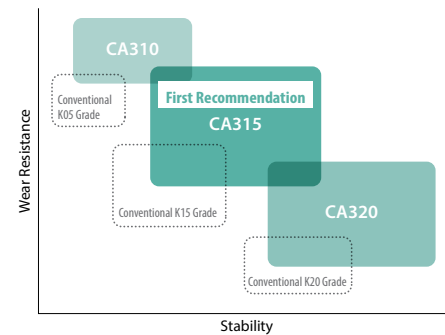

Innovative Coating Layers Produce Superior Hardness and Toughness with Excellent Fracture and Wear Resistance

Recommended K-Series Chipbreakers

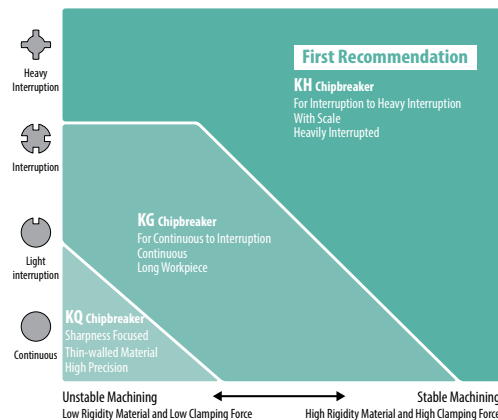

1st Recommendation

KH Chipbreaker (For Interrupted to Heavily Interrupted)

Good for Heavily Interrupted Machining
Focus on High Stability with Flat Land

KG Chipbreaker (for Continuous to Interrupted)

For Various Cast Iron Machining Applications
Chipping Resistance is Improved Despite Having a Positive Land

All 2017 Winter / Spring Offers Valid through June 30, 2017







All promo items are available exclusively through Authorized North American Kyocera Precision Tool Distributors. Please use specified Promo Code when placing orders.

To locate a distributor visit www.kyoceraprecisiontools.com/locate. Prices Shown Valid in U.S. Only.

Toolholders

Toolholder	Shank Size (Square)	Overall Length	Insert Description	Chipbreaker (Pick 1)	Grades (Pick 1)	U.S. Kit Price
	DCLN $\frac{1}{2}$ 12-4B	0.750"	CNMG432	KG KH	CA310 CA315	\$99.00
	DCLN $\frac{1}{2}$ 16-4D	1.000"	CNMG432	KG KH	CA310 CA315	\$109.00
	DDJN $\frac{1}{2}$ 12-4B	0.750"	DNMG432	KG KH	CA310 CA315	\$109.00
	DDJN $\frac{1}{2}$ 16-4D	1.000"	DNMG432	KG KH	CA310 CA315	\$119.00
	DWLN $\frac{1}{2}$ 12-4B	0.750"	WNMG432	KG KH	CA310 CA315	\$99.00
	DWLN $\frac{1}{2}$ 16-4D	1.000"	WNMG432	KG KH	CA310 CA315	\$109.00

Inserts

★ Roughing / 1st Choice ☆ Roughing / 2nd Choice	K	Material				★	☆
		Gray Cast Iron		Ductile Cast Iron			★
Insert	Dimensions (in)				CVD Coating		
	I.C.	Thickness	Hole	Corner-R (r _e)	CA310	CA315	
 Sharp Edge	CNMG 432KG	1/2	3/16	0.203	1/32	●	●
 Roughing						●	●
 Sharp Edge	DNMG 432KG	1/2	3/16	0.203	1/32	●	●
 Roughing						●	●
 Sharp Edge	WNMG 432KG	1/2	3/16	0.203	1/32	●	●
 Roughing						●	●

No chipbreaker or geometry substitutions

● : U.S. Stock

KYOCERA Precision Tools, Inc.

P: 800.823.7284 • F: 828.692.1344 • E: ctsales@kyocera.com
Official Website | www.kyoceraprecisiontools.com

MILLING SOLUTIONS

TURNING SOLUTIONS

DRILLING SOLUTIONS

SOLID ROUND SOLUTIONS

TOOL HOLDING SOLUTIONS



Steel Turning Kits

CA5-Series Inserts and Double-Clamp Holders

CA5-Series utilize a high adhesion strength coating layer with an ultra-fine interface. Long tool life and stable machining with 40% improved adhesion strength.



MILLING SOLUTIONS

TURNING SOLUTIONS

DRILLING SOLUTIONS

SOLID ROUND SOLUTIONS

TOOL HOLDING SOLUTIONS

STEEL TURNING KITS (1 Double-Clamp Holder & 10 Inserts)

Promo Code: **KYO-CA5-KIT**

Long Tool Life and High Stability Coating for Steel Turning Applications

Innovative Coating Layers Produce Superior Hardness and Toughness with Excellent Fracture and Wear Resistance

Wear Resistance Comparison (In-house Evaluation)

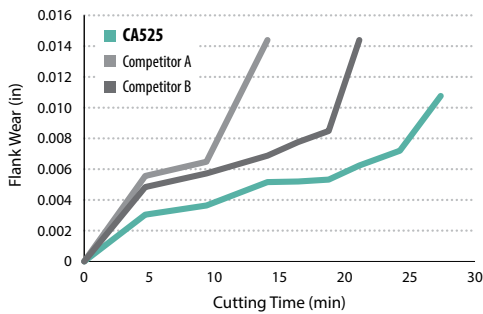

Cutting Conditions : $V_c = 980$ sfm, D.O.C. = 0.079", $f = 0.012$ ipr, Wet
Workpiece Material : 4137 Steel

Fracture Resistance Comparison (In-house Evaluation)

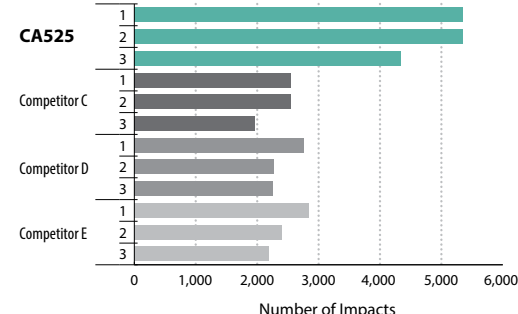

Cutting Conditions : $V_c = 980$ sfm, D.O.C. = 0.059", $f = 0.012$ ipr, Wet
Workpiece Material : 4140 Steel (4 grooves)

Grade Application Range

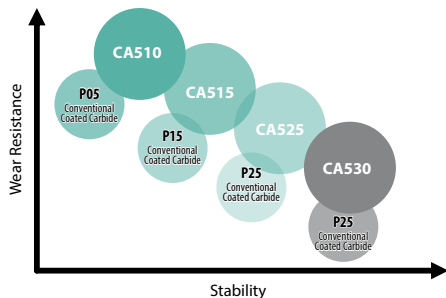

- CA525** 1st Recommendation
General Purpose Steel Machining
- CA515** Continuous to Light Interrupted
- CA510** High Speed & High Efficiency
Wear Resistance Oriented

Chipbreaker Application Range

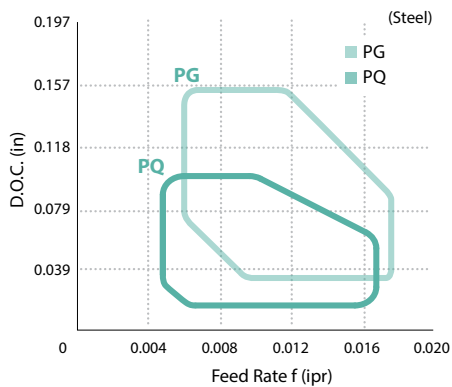

All 2017 Winter / Spring Offers Valid through June 30, 2017







All promo items are available exclusively through Authorized North American Kyocera Precision Tool Distributors. Please use specified Promo Code when placing orders.

To locate a distributor visit www.kyoceraprecisiontools.com/locate. Prices Shown Valid in U.S. Only.

Toolholders

Toolholder	Shank Size (Square)	Overall Length	Insert Description	Chipbreaker (Pick 1)	Grades (Pick 1)	U.S. Kit Price
	DCLN $\frac{1}{2}$ 12-4B	0.750"	CNMG432	PG PQ	CA510 CA515 CA525	\$99.00
	DCLN $\frac{1}{2}$ 16-4D	1.000"	CNMG432	PG PQ	CA510 CA515 CA525	\$109.00
	DDJN $\frac{1}{2}$ 12-4B	0.750"	DNMG432	PG PQ	CA510 CA515 CA525	\$109.00
	DDJN $\frac{1}{2}$ 16-4D	1.000"	DNMG432	PG PQ	CA510 CA515 CA525	\$119.00
	DWLN $\frac{1}{2}$ 12-4B	0.750"	WNMG432	PG PQ	CA510 CA515 CA525	\$99.00
	DWLN $\frac{1}{2}$ 16-4D	1.000"	WNMG432	PG PQ	CA510 CA515 CA525	\$109.00

Inserts

★ Roughing / 1st Choice ☆ Roughing / 2nd Choice	P	Carbon Steel / Alloy Steel				☆	★	★
		Mold Steel				☆	★	★
Insert	Dimensions (in)				CVD Coating			
	I.C.	Thickness	Hole	Corner-R (re)	CA510	CA515	CA525	
 Medium-Roughing	1/2	3/16	0.203	1/32	●	●	●	
 Finishing-Medium					●	●	●	
 Medium-Roughing	1/2	3/16	0.203	1/32	●	●	●	
 Finishing-Medium					●	●	●	
 Medium-Roughing	1/2	3/16	0.203	1/32	●	●	●	
 Finishing-Medium					●	●	●	

No chipbreaker or geometry substitutions

● : U.S. Stock

KYOCERA Precision Tools, Inc.

P: 800.823.7284 • F: 828.692.1344 • E: ctsales@kyocera.com
Official Website | www.kyoceraprecisiontools.com

MILLING SOLUTIONS

TURNING SOLUTIONS

DRILLING SOLUTIONS

SOLID ROUND SOLUTIONS

TOOL HOLDING SOLUTIONS



Stainless Steel Turning Kits

CA65-Series Inserts and Double-Clamp Holders

CA65-Series CVD coated carbide with thin ultra-fine TiCN coating for stainless steel, heat-resistant steel, and general steel maintains stable machining performance for various applications.

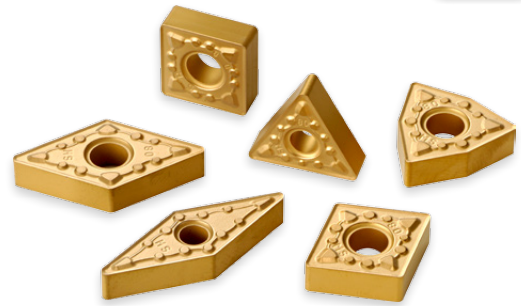

MILLING SOLUTIONS

TURNING SOLUTIONS

DRILLING SOLUTIONS

SOLID ROUND SOLUTIONS

TOOL HOLDING SOLUTIONS

STAINLESS STEEL TURNING KITS (1 Double-Clamp Holder & 10 Inserts)

Promo Code: *KYO-CA65-KIT*

Excellent Fracture Toughness and Machining Stability

Low Cutting Resistance and Reduced Adhesion and Edge Buildup

CA6526 Cutting Performance

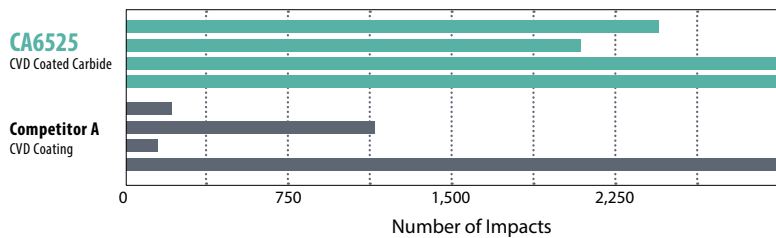

Cutting Conditions: $V_c = 330$ sfm, D.O.C. = 0.02", $f = 0.012$ ipr, Wet
Workpiece Material: 304 SS, Insert: CNMG432 PR1125, 4 Grooves

Grade Application Range

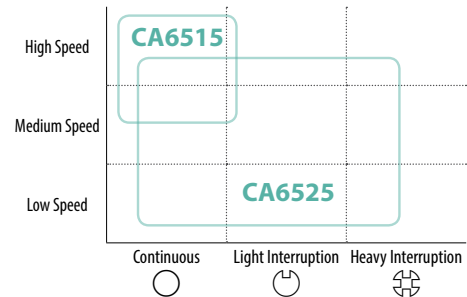

High Performance Chipbreakers for Various Machining Applications

MS Chipbreaker

- First recommendation for medium to roughing
- Positive land
- Tough cutting edge
- Good chip control

MQ Chipbreaker

- For finishing to medium
- Large rake angle with circular edge line
- Low cutting force and good chip control

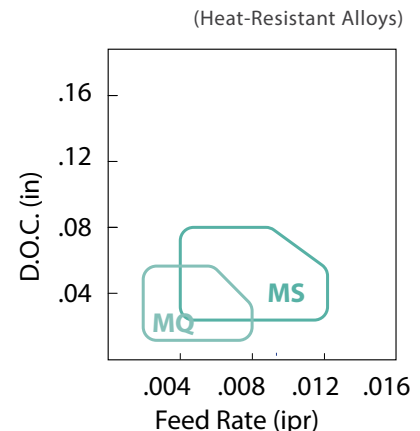
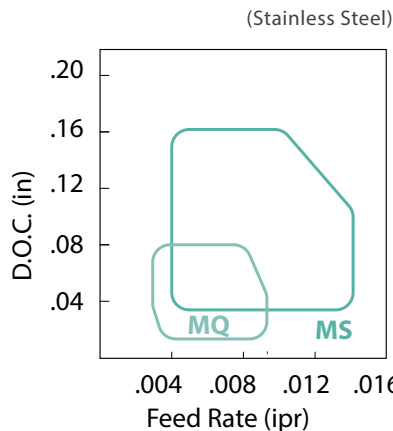



All 2017 Winter / Spring Offers Valid through June 30, 2017







All promo items are available exclusively through Authorized North American Kyocera Precision Tool Distributors. Please use specified Promo Code when placing orders.

To locate a distributor visit www.kyoceraprecisiontools.com/locate. Prices Shown Valid in U.S. Only.

Toolholders

Toolholder	Shank Size (Square)	Overall Length	Insert Description	Chipbreaker (Pick 1)	Grades (Pick 1)	U.S. Kit Price
	DCLN $\frac{1}{2}$ 12-4B	0.750"	CNMG432	MS MQ	CA6515 CA6525	\$99.00
	DCLN $\frac{1}{2}$ 16-4D	1.000"	CNMG432	MS MQ	CA6515 CA6525	\$109.00
	DDJN $\frac{1}{2}$ 12-4B	0.750"	DNMG432	MS MQ	CA6515 CA6525	\$109.00
	DDJN $\frac{1}{2}$ 16-4D	1.000"	DNMG432	MS MQ	CA6515 CA6525	\$119.00
	DWLN $\frac{1}{2}$ 12-4B	0.750"	WNMG432	MS MQ	CA6515 CA6525	\$99.00
	DWLN $\frac{1}{2}$ 16-4D	1.000"	WNMG432	MS MQ	CA6515 CA6525	\$109.00

Inserts

★ Roughing / 1st Choice ☆ Roughing / 2nd Choice	P	Stainless Steel				★	★
	S	Heat Resistant Alloy (Ni-base)				☆	☆
Insert	Dimensions (in)				CVD Coating		
	I.C.	Thickness	Hole	Corner-R (re)	CA6515	CA6525	
 Medium-Roughing	1/2	3/16	0.203	1/32	●	●	
 Finishing-Medium					●	●	
 Medium-Roughing	1/2	3/16	0.203	1/32	●	●	
 Finishing-Medium					●	●	
 Medium-Roughing	1/2	3/16	0.203	1/32	●	●	
 Finishing-Medium					●	●	

No chipbreaker or geometry substitutions

● : U.S. Stock

KYOCERA Precision Tools, Inc.

P: 800.823.7284 • F: 828.692.1344 • E: ctsales@kyocera.com
Official Website | www.kyoceraprecisiontools.com

MILLING SOLUTIONS

TURNING SOLUTIONS

DRILLING SOLUTIONS

SOLID ROUND SOLUTIONS

TOOL HOLDING SOLUTIONS



Heat-Resistant Alloy Turning Kits

PR1535 / PR13-Series Inserts and Double-Clamp Holders

Using MEGACOAT coating technology for superior protection against wear and fracturing, these PVD coated carbides are perfect for nickel-based, iron-based, and cobalt-based heat-resistant alloys, titanium, and stainless steel.



MILLING SOLUTIONS

TURNING SOLUTIONS

DRILLING SOLUTIONS

SOLID ROUND SOLUTIONS

TOOL HOLDING SOLUTIONS

HEAT-RESISTANT ALLOY TURNING KITS (1 Double-Clamp Holder & 10 Inserts)

Promo Code: **KYO-PR-KIT**

PR1535 MEGACOAT NANO

Stable Machining of Difficult-to-cut Materials

For Heat-Resistant Alloy, Titanium Alloy, and Stainless Steel



Features

- The coarse grain structure and uniform particle size correspond to improved heat resistance, with conductivity values decreased by 11%
- The uniform structure also reduces crack propagation

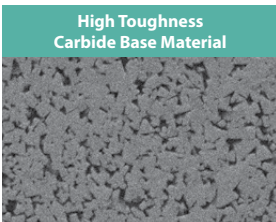

High Toughness Carbide Base Material



Cracking Comparison by Diamond Indentor

Conventional Material

PR1535 Base Material

Long Cracks

Short Cracks
(High Impact Improvement)

Chipbreaker Application Range

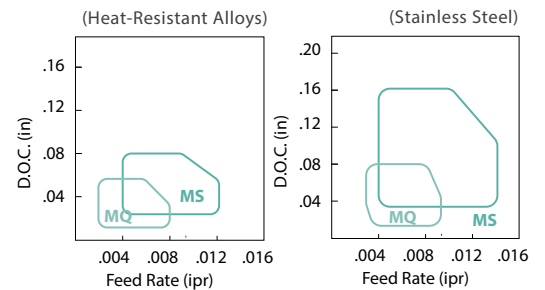

PR13⁰⁵ / PR13¹⁰ / PR13²⁵ MEGACOAT

Grades for Heat-Resistant Alloys

PVD Coated Carbide for Nickel-based, Iron-based, and Cobalt-based Heat-Resistant Alloys

The PR13-Series grades for heat-resistant alloys have excellent fracture resistance and stabilization.

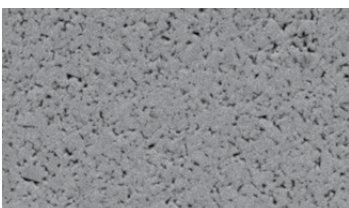

A uniform grain structure provides superior thermal shock resistance and hardness stability

Insert Grade	Application
PR1305	Continuous / Finishing
PR1310	Mid to High-Speed Machining / Light Interruption
PR1325	Interrupted / Roughing

PR13-Series Application Range

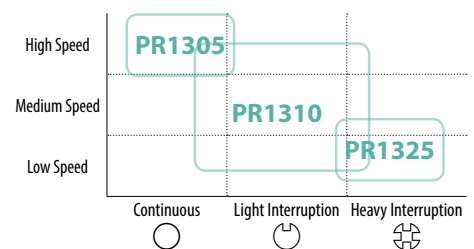

All 2017 Winter / Spring Offers Valid through June 30, 2017







All promo items are available exclusively through Authorized North American Kyocera Precision Tool Distributors. Please use specified Promo Code when placing orders.

To locate a distributor visit www.kyoceraprecisiontools.com/locate. Prices Shown Valid in U.S. Only.

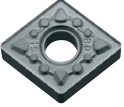
Toolholders

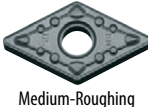
Toolholder		Shank Size (Square)	Overall Length	Insert Description	Chipbreaker (Pick 1)	Grades (Pick 1)	U.S. Kit Price
	DCLN[®] 12-4B	0.750"	4.500"	CNMG432	MS MQ	PR1305 PR1310 PR1325 PR1535	\$99.00
	DCLN[®] 16-4D	1.000"	6.000"	CNMG432	MS MQ	PR1305 PR1310 PR1325 PR1535	\$109.00
	DDJN[®] 12-4B	0.750"	4.500"	DNMG432	MS MQ	PR1305 PR1310 PR1325 PR1535	\$109.00
	DDJN[®] 16-4D	1.000"	6.000"	DNMG432	MS MQ	PR1305 PR1310 PR1325 PR1535	\$119.00
	DWLN[®] 12-4B	0.750"	4.500"	WNMG432	MS MQ	PR1305 PR1310 PR1325 PR1535	\$99.00
	DWLN[®] 16-4D	1.000"	6.000"	WNMG432	MS MQ	PR1305 PR1310 PR1325 PR1535	\$109.00

Inserts

★ Roughing / 1st Choice ☆ Roughing / 2nd Choice	P	Stainless Steel							★
	S	Heat Resistant Alloy (Ni-base)				★	★	★	★
		Titanium Alloy (Ti-6Al-4V)							★
Insert	Dimensions (in)				MEGACOAT				MEGACOAT NANO
	I.C.	Thickness	Hole	Corner-R (rε)	PR1305	PR1310	PR1325	PR1535	
 Medium-Roughing	1/2	3/16	0.203	1/32	●	●	●	●	
CNMG 432MS									
 Finishing-Medium					●	●	●	●	
CNMG 432MQ									
 Medium-Roughing	1/2	3/16	0.203	1/32	●	●	●	●	
DNMG 432MS									
 Finishing-Medium					●	●	●	●	
DNMG 432MQ									
 Medium-Roughing	1/2	3/16	0.203	1/32	●	●	●	●	
WNMG 432MS									
 Finishing-Medium					●	●	●	●	
WNMG 432MQ									

No chipbreaker or geometry substitutions

KYOCERA Precision Tools, Inc.

● : U.S. Stock

P: 800.823.7284 • F: 828.692.1344 • E: ctsales@kyocera.com
Official Website | www.kyoceraprecisiontools.com

MILLING SOLUTIONS

TURNING SOLUTIONS

DRILLING SOLUTIONS

SOLID ROUND SOLUTIONS

TOOL HOLDING SOLUTIONS

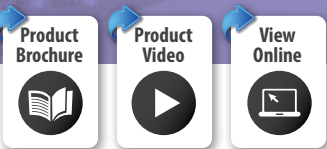

DRA Magic Drill Kits

High Efficiency and Low Cutting Force Modular Drill

Excellent Hole Accuracy

S-curve reduces thrust force and controls vibration

Fine Chip Breaking Even in Deep Hole Drilling Applications

Optimized chip thinning for stable chip evacuation

Long Tool Life and Stable Machining of Various Workpieces

MEGACOAT NANO grade PR1535 is used to machine various materials from steel to stainless steel



MILLING SOLUTIONS

TURNING SOLUTIONS

DRILLING SOLUTIONS

SOLID ROUND SOLUTIONS

TOOL HOLDING SOLUTIONS

1 Low Cutting Force Design Improves Hole Accuracy

The special chisel edge with S-curve reduces thrust force and controls vibration.

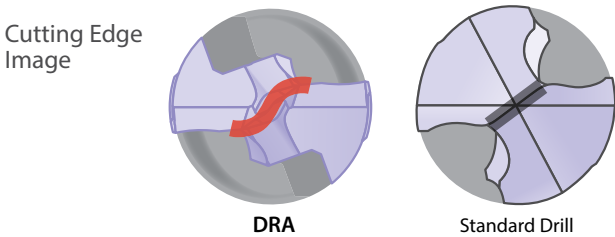

Low Cutting Force Comparison (In-house Evaluation)

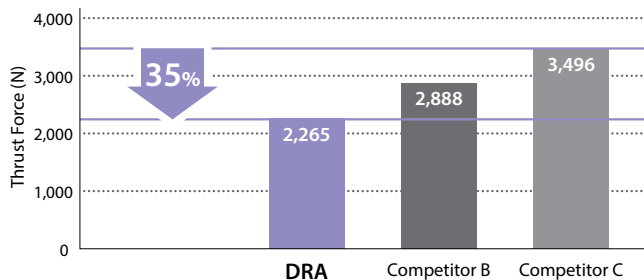

Cutting Conditions : Vc = 390sfm, f = 0.010ipr, Drilling Diameter Ø0.551", Drilling Depth 1.772", Wet

2 Optimal Web Thickness Limits Deflection

The hole accuracy is improved by controlling drill deflection with a 20% thicker web compared with Competitor A.

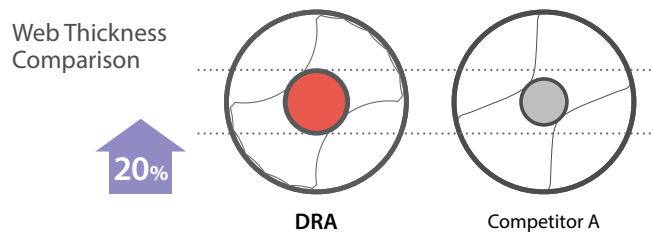

Roundness · Cylindricity Comparison (In-house Evaluation)

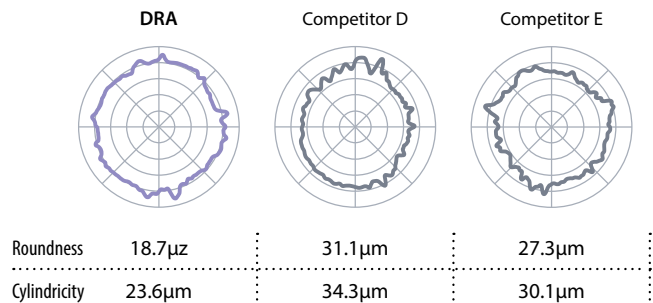

Cutting Conditions : Vc = 390sfm, f = 0.012ipr, Drilling Diameter Ø0.551", Measurement Position 2.165", Wet Workpiece : 1049 Steel

All 2017 Winter / Spring Offers Valid through June 30, 2017

All promo items are available exclusively through Authorized North American Kyocera Precision Tool Distributors. Please use specified Promo Code when placing orders.

To locate a distributor visit www.kyoceraprecisiontools.com/locate. Prices Shown Valid in U.S. Only.

DRA Toolholders (with Flange - 3D)

Choose (1) 3D Drill Body and (2) Inserts for Special Kit Price or Purchase (10) Inserts and Receive a 3D Drill Body FREE

Chosen inserts must fit purchased drill body but do not need to be the same.

Promo Code: **KYO-DRA-KIT**

Promo Code: **KYO-DRA-FREE**

3D

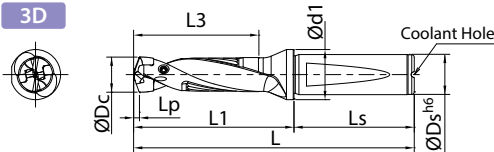

For Lp dimension, reference insert dimension table.



Part Number	Stock	U.S. Kit Price	Dimension (in)							Applicable Insert See Page 26-27	Seat Size	Spare Parts		
			ØDc		ØDs	L	L1	L3	Ls			Ød1	Clamp Screw	Wrench
			min.	max.										
SF0500-DRA080M-3	●	\$249.00	0.313	0.334	0.500	3.307	1.535	1.004	1.772	0.630	DA0794M-GM ~ DA0840M-GM	080	HS-2524TRP	
SF0500-DRA085M-3	●	\$249.00	0.335	0.354		3.386	1.614	1.063			DA0850M-GM ~ DA0890M-GM	085		
SF0500-DRA090M-3	●	\$249.00	0.354	0.374		3.465	1.693	1.122			DA0900M-GM ~ DA0940M-GM	090		
SF0500-DRA095M-3	●	\$249.00	0.374	0.393		3.543	1.772	1.181			DA0950M-GM ~ DA0990M-GM	095		
SF0625-DRA100M-3	●	\$249.00	0.394	0.413	0.625	3.740	1.850	1.240	1.890	0.787	DA1000M-GM ~ DA1040M-GM	100	HS-2534TRP	FTP-5
SF0625-DRA105M-3	●	\$269.00	0.413	0.433		3.819	1.929	1.299			DA1050M-GM ~ DA1090M-GM	105		
SF0625-DRA110M-3	●	\$269.00	0.433	0.452		3.937	2.047	1.358			DA1100M-GM ~ DA1140M-GM	110		
SF0625-DRA115M-3	●	\$269.00	0.453	0.472		4.016	2.126	1.417			DA1150M-GM ~ DA1190M-GM	115		
SF0625-DRA120M-3	●	\$269.00	0.472	0.492		4.094	2.205	1.476			DA1200M-GM ~ DA1240M-GM	120		
SF0625-DRA125M-3	●	\$269.00	0.492	0.511		4.173	2.283	1.535			DA1250M-GM ~ DA1290M-GM	125		
SF0625-DRA130M-3	●	\$269.00	0.512	0.531		4.252	2.362	1.594			DA1300M-GM ~ DA1340M-GM	130		
SF0625-DRA135M-3	●	\$279.00	0.531	0.551		4.331	2.441	1.654			DA1350M-GM ~ DA1390M-GM	135		
SF0625-DRA140M-3	●	\$279.00	0.551	0.570		4.409	2.520	1.713			DA1400M-GM ~ DA1440M-GM	140		
SF0625-DRA145M-3	●	\$279.00	0.571	0.590		4.488	2.598	1.772			DA1450M-GM ~ DA1490M-GM	145		
SF0750-DRA150M-3	●	\$299.00	0.591	0.630	0.750	4.764	2.795	1.890	1.969	0.984	DA1500M-GM ~ DA1590M-GM	150	HS-3048TRP	FTP-6
SF0750-DRA160M-3	●	\$299.00	0.630	0.669		4.961	2.992	2.008			DA1600M-GM ~ DA1690M-GM	160		
SF0750-DRA170M-3	●	\$309.00	0.669	0.708		5.118	3.150	2.126			DA1700M-GM ~ DA1790M-GM	170		
SF0750-DRA180M-3	●	\$339.00	0.709	0.748		5.315	3.346	2.244			DA1800M-GM ~ DA1890M-GM	180		
SF0750-DRA190M-3	●	\$359.00	0.748	0.787		5.472	3.504	2.362			DA1900M-GM ~ DA1990M-GM	190		
SF1000-DRA200M-3	●	\$419.00	0.787	0.826	1.000	5.866	3.661	2.480	2.205	1.260	DA2000M-GM ~ DA2090M-GM	200	HS-4067TRP	FTP-7
SF1000-DRA210M-3	●	\$429.00	0.827	0.866		6.024	3.819	2.598			DA2100M-GM ~ DA2150M-GM	210		
SF1000-DRA220M-3	●	\$429.00	0.866	0.905		6.220	4.016	2.717			DA2200M-GM ~ DA2250M-GM	220		
SF1000-DRA230M-3	●	\$459.00	0.906	0.944		6.378	4.173	2.835			DA2300M-GM ~ DA2381M-GM	230		
SF1000-DRA240M-3	●	\$469.00	0.945	0.983		6.535	4.331	2.953			DA2400M-GM ~ DA2450M-GM	240		
SF1000-DRA250M-3	●	\$509.00	0.984	1.004		6.693	4.488	3.071			DA2500M-GM ~ DA2550M-GM	250		

● : U.S. Stock

Kit Includes 1 Drill Body and 2 Inserts

KYOCERA Precision Tools, Inc.

P: 800.823.7284 • F: 828.692.1344 • E: ctsales@kyocera.com
 Official Website | www.kyoceraprecisiontools.com

MILLING SOLUTIONS

TURNING SOLUTIONS

DRILLING SOLUTIONS

SOLID ROUND SOLUTIONS

TOOL HOLDING SOLUTIONS

DRA Toolholders (with Flange - 5D)

Choose (1) 5D Drill Body and (2) Inserts for Special Kit Price or Purchase (11) Inserts and Receive a 5D Drill Body FREE

Chosen inserts must fit purchased drill body but do not need to be the same.

Promo Code: **KYO-DRA-KIT**

Promo Code: **KYO-DRA-FREE**

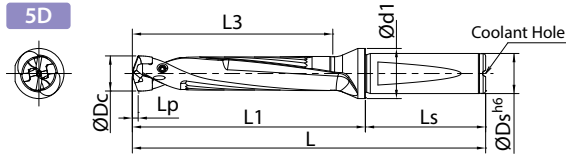

For Lp dimension, reference insert dimension table.



Part Number	Stock	U.S. Kit Price	Dimension (in)								Applicable Insert See Page 26-27	Seat Size	Spare Parts	
			ØDc		ØDs	L	L1	L3	Ls	Ød1			Clamp Screw	Wrench
			min.	max.										
SF0500-DRA080M-5	●	\$279.00	0.313	0.334	0.500	3.976	2.205	1.673	1.772	0.630	DA0794M-GM ~ DA0840M-GM	080	HS-2524TRP	
SF0500-DRA085M-5	●	\$279.00	0.335	0.354		4.094	2.323	1.772			DA0850M-GM ~ DA0890M-GM	085		
SF0500-DRA090M-5	●	\$279.00	0.354	0.374		4.213	2.441	1.870			DA0900M-GM ~ DA0940M-GM	090		
SF0500-DRA095M-5	●	\$279.00	0.374	0.393		4.331	2.559	1.969			DA0950M-GM ~ DA0990M-GM	095		
SF0625-DRA100M-5	●	\$289.00	0.394	0.413	0.625	4.567	2.677	2.067	1.890	0.787	DA1000M-GM ~ DA1040M-GM	100	HS-2534TRP	FTP-5
SF0625-DRA105M-5	●	\$309.00	0.413	0.433		4.685	2.795	2.165			DA1050M-GM ~ DA1090M-GM	105		
SF0625-DRA110M-5	●	\$309.00	0.433	0.452		4.843	2.953	2.264			DA1100M-GM ~ DA1140M-GM	110		
SF0625-DRA115M-5	●	\$299.00	0.453	0.472		4.961	3.071	2.362			DA1150M-GM ~ DA1190M-GM	115		
SF0625-DRA120M-5	●	\$309.00	0.472	0.492		5.079	3.189	2.461			DA1200M-GM ~ DA1240M-GM	120		
SF0625-DRA125M-5	●	\$309.00	0.492	0.511		5.197	3.307	2.559			DA1250M-GM ~ DA1290M-GM	125		
SF0625-DRA130M-5	●	\$309.00	0.512	0.531		5.315	3.425	2.657			DA1300M-GM ~ DA1340M-GM	130		
SF0625-DRA135M-5	●	\$309.00	0.531	0.551		5.433	3.543	2.756			DA1350M-GM ~ DA1390M-GM	135		
SF0625-DRA140M-5	●	\$309.00	0.551	0.570		5.551	3.661	2.854			DA1400M-GM ~ DA1440M-GM	140		
SF0625-DRA145M-5	●	\$309.00	0.571	0.590		5.669	3.780	2.953			DA1450M-GM ~ DA1490M-GM	145		
SF0750-DRA150M-5	●	\$339.00	0.591	0.630		0.750	6.024	4.055			3.150	1.969		
SF0750-DRA160M-5	●	\$339.00	0.630	0.669	6.299		4.331	3.346	DA1600M-GM ~ DA1690M-GM	160				
SF0750-DRA170M-5	●	\$349.00	0.669	0.708	6.535		4.567	3.543	DA1700M-GM ~ DA1790M-GM	170				
SF0750-DRA180M-5	●	\$389.00	0.709	0.748	6.811		4.843	3.740	DA1800M-GM ~ DA1890M-GM	180				
SF0750-DRA190M-5	●	\$409.00	0.748	0.787	7.047		5.079	3.937	DA1900M-GM ~ DA1990M-GM	190				
SF1000-DRA200M-5	●	\$479.00	0.787	0.826	1.000		7.520	5.315	4.134	2.205	1.260		DA2000M-GM ~ DA2090M-GM	200
SF1000-DRA210M-5	●	\$489.00	0.827	0.866		7.756	5.551	4.331	DA2100M-GM ~ DA2150M-GM			210		
SF1000-DRA220M-5	●	\$489.00	0.866	0.905		8.031	5.827	4.528	DA2200M-GM ~ DA2250M-GM			220		
SF1000-DRA230M-5	●	\$519.00	0.906	0.944		8.268	6.063	4.724	DA2300M-GM ~ DA2381M-GM			230		
SF1000-DRA240M-5	●	\$539.00	0.945	0.983		8.504	6.299	4.921	DA2400M-GM ~ DA2450M-GM			240		
SF1000-DRA250M-5	●	\$579.00	0.984	1.004		8.740	6.535	5.116	DA2500M-GM ~ DA2550M-GM			250		

● : U.S. Stock

Kit Includes 1 Drill Body and 2 Inserts

All 2017 Winter / Spring Offers Valid through June 30, 2017

All promo items are available exclusively through Authorized North American Kyocera Precision Tool Distributors. Please use specified Promo Code when placing orders.

To locate a distributor visit www.kyoceraprecisiontools.com/locate. Prices Shown Valid in U.S. Only.

MILLING SOLUTIONS
TURNING SOLUTIONS
DRILLING SOLUTIONS
SOLID ROUND SOLUTIONS
TOOL HOLDING SOLUTIONS

DRA Toolholders (with Flange - 8D)

Choose (1) 8D Drill Body and (2) Inserts for Special Kit Price or Purchase (12) Inserts and Receive a 8D Drill Body FREE

Chosen inserts must fit purchased drill body but do not need to be the same.

Promo Code: **KYO-DRA-KIT**

Promo Code: **KYO-DRA-FREE**

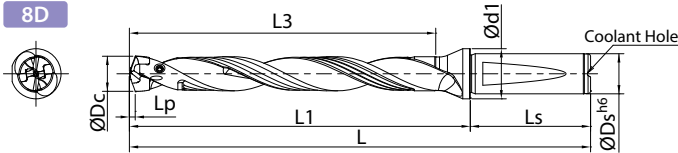

For Lp dimension, reference insert dimension table.



Part Number	Stock	U.S. Kit Price	Dimension (in)							Applicable Insert See Page 26-27	Seat Size	Spare Parts		
			ØDc		ØDs	L	L1	L3	Ls			Ød1	Clamp Screw	Wrench
			min.	max.										
SF0500-DRA080M-8	●	\$329.00	0.313	0.334	0.500	4.961	3.189	2.677	1.772	0.630	DA0794M-GM ~ DA0840M-GM	080	HS-2524TRP	
SF0500-DRA085M-8	●	\$329.00	0.335	0.354		5.157	3.386	2.835			DA0850M-GM ~ DA0890M-GM	085		
SF0500-DRA090M-8	●	\$329.00	0.354	0.374		5.315	3.543	2.992			DA0900M-GM ~ DA0940M-GM	090		
SF0500-DRA095M-8	●	\$329.00	0.374	0.393		5.512	3.740	3.150			DA0950M-GM ~ DA0990M-GM	095		
SF0625-DRA100M-8	●	\$339.00	0.394	0.413	0.625	5.787	3.898	3.307	1.890	0.787	DA1000M-GM ~ DA1040M-GM	100	HS-2534TRP	FTP-5
SF0625-DRA105M-8	●	\$359.00	0.413	0.433		5.984	4.094	3.465			DA1050M-GM ~ DA1090M-GM	105		
SF0625-DRA110M-8	●	\$359.00	0.433	0.452		6.181	4.291	3.622			DA1100M-GM ~ DA1140M-GM	110		
SF0625-DRA115M-8	●	\$359.00	0.453	0.472		6.378	4.488	3.780			DA1150M-GM ~ DA1190M-GM	115		
SF0625-DRA120M-8	●	\$369.00	0.472	0.492		6.535	4.646	3.937			DA1200M-GM ~ DA1240M-GM	120		
SF0625-DRA125M-8	●	\$359.00	0.492	0.511		6.732	4.843	4.094			DA1250M-GM ~ DA1290M-GM	125		
SF0625-DRA130M-8	●	\$369.00	0.512	0.531		6.890	5.000	4.252			DA1300M-GM ~ DA1340M-GM	130		
SF0625-DRA135M-8	●	\$359.00	0.531	0.551		7.087	5.197	4.409			DA1350M-GM ~ DA1390M-GM	135		
SF0625-DRA140M-8	●	\$359.00	0.551	0.570		7.244	5.354	4.567			DA1400M-GM ~ DA1440M-GM	140		
SF0625-DRA145M-8	●	\$359.00	0.571	0.590		7.441	5.551	4.724			DA1450M-GM ~ DA1490M-GM	145		
SF0750-DRA150M-8	●	\$379.00	0.591	0.630	0.750	7.913	5.945	5.039	1.969	0.984	DA1500M-GM ~ DA1590M-GM	150	HS-3048TRP	FTP-6
SF0750-DRA160M-8	●	\$389.00	0.630	0.669		8.307	6.339	5.354			DA1600M-GM ~ DA1690M-GM	160		
SF0750-DRA170M-8	●	\$399.00	0.669	0.708		8.661	6.693	5.669			DA1700M-GM ~ DA1790M-GM	170		
SF0750-DRA180M-8	●	\$449.00	0.709	0.748		9.055	7.087	5.984			DA1800M-GM ~ DA1890M-GM	180		
SF0750-DRA190M-8	●	\$469.00	0.748	0.787		9.409	7.441	6.299			DA1900M-GM ~ DA1990M-GM	190		
SF1000-DRA200M-8	●	\$549.00	0.787	0.826	1.000	10.000	7.795	6.614	2.205	1.260	DA2000M-GM ~ DA2090M-GM	200	HS-4067TRP	FTP-7
SF1000-DRA210M-8	●	\$559.00	0.827	0.866		10.354	8.150	6.929			DA2100M-GM ~ DA2150M-GM	210		
SF1000-DRA220M-8	●	\$559.00	0.866	0.905		10.748	8.543	7.244			DA2200M-GM ~ DA2250M-GM	220		
SF1000-DRA230M-8	●	\$599.00	0.906	0.944		11.102	8.898	7.559			DA2300M-GM ~ DA2381M-GM	230		
SF1000-DRA240M-8	●	\$609.00	0.945	0.983		11.457	9.252	7.874			DA2400M-GM ~ DA2450M-GM	240		
SF1000-DRA250M-8	●	\$659.00	0.984	1.004		11.811	9.606	8.189			DA2500M-GM ~ DA2550M-GM	250		

● : U.S. Stock

Kit Includes 1 Drill Body and 2 Inserts

KYOCERA Precision Tools, Inc.

P: 800.823.7284 • F: 828.692.1344 • E: ctsales@kyocera.com
 Official Website | www.kyoceraprecisiontools.com

MILLING SOLUTIONS

TURNING SOLUTIONS

DRILLING SOLUTIONS

SOLID ROUND SOLUTIONS

TOOL HOLDING SOLUTIONS

DRA Inserts

Cutting Diameter $\varnothing 0.313'' \sim \varnothing 0.528''$ ($\varnothing 7.94\text{mm} \sim \varnothing 13.40\text{mm}$)

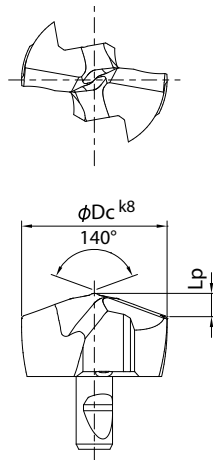
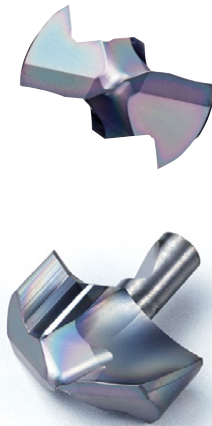

k8 Tolerance

$\varnothing D_c$ (in)	k8 (in)	$\varnothing D_c$ (mm)	k8 (mm)
0.313 ~ 0.394	+0.0009 0	7.94 ~ 10.00	+0.022 0
0.394 ~ 0.709	+0.0011 0	10.10 ~ 18.00	+0.027 0
0.713 ~ 1.004	+0.0013 0	18.10 ~ 25.50	+0.033 0

k8 is the dimension tolerance of the insert.
It is not the tolerance of the cutting diameter.

1st Recommendation

Steel PR1535	Cast Iron PR1525
-----------------	---------------------

Description	Dimensions			Grade		Seat Size	Applicable Toolholder
	$\varnothing D_c$		Lp (in)	PR1535	PR1525		
	in	mm					
DA0794M-GM	0.313	7.94	0.053	●	●	080	SS0375-DRA080M-○ SF0500-DRA080M-○
DA0800M-GM	0.315	8.00	0.053	●	●		
DA0810M-GM	0.319	8.10	0.054	●	●		
DA0818M-GM	0.322	8.18	0.054	●	■		
DA0820M-GM	0.323	8.20	0.055	●	●		
DA0830M-GM	0.327	8.30	0.055	●	●		
DA0840M-GM	0.331	8.40	0.056	●	●		
DA0850M-GM	0.335	8.50	0.057	●	●		
DA0860M-GM	0.339	8.60	0.057	●	●	085	SS0375-DRA085M-○ SF0500-DRA085M-○
DA0870M-GM	0.343	8.70	0.058	●	●		
DA0880M-GM	0.346	8.80	0.059	●	●		
DA0890M-GM	0.350	8.90	0.060	●	●		
DA0900M-GM	0.354	9.00	0.060	●	●	090	SS0375-DRA090M-○ SF0500-DRA090M-○
DA0910M-GM	0.358	9.10	0.061	●	●		
DA0920M-GM	0.362	9.20	0.061	●	●		
DA0930M-GM	0.366	9.30	0.062	●	●		
DA0940M-GM	0.370	9.40	0.063	●	●	095	SS0500-DRA095M-○ SF0500-DRA095M-○
DA0950M-GM	0.374	9.50	0.063	●	●		
DA0953M-GM	0.375	9.53	0.064	●	■		
DA0960M-GM	0.378	9.60	0.064	●	●		
DA0970M-GM	0.382	9.70	0.065	●	●	100	SS0500-DRA100M-○ SF0625-DRA100M-○
DA0980M-GM	0.386	9.80	0.066	●	●		
DA0990M-GM	0.390	9.90	0.066	●	●		
DA1000M-GM	0.394	10.00	0.067	●	●		
DA1010M-GM	0.398	10.10	0.068	●	●	100	SS0500-DRA100M-○ SF0625-DRA100M-○
DA1020M-GM	0.402	10.20	0.068	●	●		
DA1030M-GM	0.406	10.30	0.069	●	●		
DA1040M-GM	0.409	10.40	0.070	●	●		

Description	Dimensions			Grade		Seat Size	Applicable Toolholder
	$\varnothing D_c$		Lp (in)	PR1535	PR1525		
	in	mm					
DA1050M-GM	0.413	10.50	0.071	●	●	105	SS0500-DRA105M-○ SF0625-DRA105M-○
DA1060M-GM	0.417	10.60	0.071	●	●		
DA1070M-GM	0.421	10.70	0.072	●	●		
DA1072M-GM	0.422	10.72	0.072	●	■		
DA1080M-GM	0.425	10.80	0.073	●	●		
DA1090M-GM	0.429	10.90	0.073	●	●		
DA1100M-GM	0.433	11.00	0.074	●	●	110	SS0500-DRA110M-○ SF0625-DRA110M-○
DA1110M-GM	0.437	11.10	0.074	●	●		
DA1120M-GM	0.441	11.20	0.075	●	●		
DA1130M-GM	0.445	11.30	0.076	●	●		
DA1140M-GM	0.449	11.40	0.076	●	●	115	SS0500-DRA115M-○ SF0625-DRA115M-○
DA1150M-GM	0.453	11.50	0.077	●	●		
DA1160M-GM	0.457	11.60	0.078	●	●		
DA1170M-GM	0.461	11.70	0.079	●	●		
DA1180M-GM	0.465	11.80	0.079	●	●	120	SS0625-DRA120M-○ SF0625-DRA120M-○
DA1190M-GM	0.469	11.90	0.080	●	●		
DA1200M-GM	0.472	12.00	0.080	●	●		
DA1210M-GM	0.476	12.10	0.081	●	●		
DA1220M-GM	0.480	12.20	0.081	●	●	125	SS0625-DRA125M-○ SF0625-DRA125M-○
DA1230M-GM	0.484	12.30	0.082	●	●		
DA1240M-GM	0.488	12.40	0.083	●	●		
DA1250M-GM	0.492	12.50	0.083	●	●		
DA1260M-GM	0.496	12.60	0.084	●	●	130	SS0625-DRA130M-○ SF0625-DRA130M-○
DA1270M-GM	0.500	12.70	0.085	●	●		
DA1280M-GM	0.504	12.80	0.086	●	●		
DA1290M-GM	0.508	12.90	0.086	●	●		
DA1300M-GM	0.512	13.00	0.087	●	●	130	SS0625-DRA130M-○ SF0625-DRA130M-○
DA1310M-GM	0.516	13.10	0.087	●	●		
DA1320M-GM	0.520	13.20	0.088	●	●		
DA1330M-GM	0.524	13.30	0.089	●	●		
DA1340M-GM	0.528	13.40	0.089	●	●		

● : U.S. Stock ■ : Made to Order

Inserts Sold in 1 Piece Boxes | Kits Include 2 Inserts

All 2017 Winter / Spring Offers Valid through June 30, 2017

All promo items are available exclusively through Authorized North American Kyocera Precision Tool Distributors. Please use specified Promo Code when placing orders.

To locate a distributor visit www.kyoceraprecisiontools.com/locate. Prices Shown Valid in U.S. Only.

DRZ Magic Drill Kits

Stable and Efficient Indexable Drills

Four Cutting Edges per Insert

Promotes cost savings and increased efficiency with a single insert in both pockets

Smooth Chip Evacuation

Molded chipbreaker produces three separate chips for smooth chip evacuation

MEGACOAT PVD for Long Tool Life

MEGACOAT PVD coated carbides for stable machining of a variety of applications



MILLING SOLUTIONS

TURNING SOLUTIONS

DRILLING SOLUTIONS

SOLID ROUND SOLUTIONS

TOOL HOLDING SOLUTIONS

DRZ Magic Drill Inserts													
Usage Classification		P	Carbon Steel / Alloy Steel					★	☆				
			Mold Steel					★					
★ 1st Choice ☆ 2nd Choice		M	Stainless Steel					☆	★				
			K	Gray Cast Iron							★		
		Ductile Cast Iron											
		N	Non-ferrous Metals									★	
Insert		Part Number	Dimensions (in)					Angle	MEGACOAT				Uncoated Carbide
			A	T	Ød	W	rε	α	PR1230	PR1225	PR1210	KW10	
	ZCMT 050203	0.232	0.094	0.091	0.107	0.012	7°	●	●	●	●		
	06T204	0.276	0.110	0.098	0.236	0.016	7°	●	●	●	●		
	080304	0.381	0.125	0.114	0.323	0.016	7°	●	●	●	●		
	10T304	0.473	0.156	0.173	0.409	0.016	7°	●	●	●	●		
	12T306	0.562	0.156	0.220	0.504	0.024	7°	●	●	●	●		
	150408	0.702	0.187	0.220	0.622	0.031	7°	●	●	●	●		
	200608	0.898	0.250	0.256	0.799	0.031	7°	●					

● : U.S. Stock

All 2017 Winter / Spring Offers Valid through June 30, 2017

All promo items are available exclusively through Authorized North American Kyocera Precision Tool Distributors. Please use specified Promo Code when placing orders.

To locate a distributor visit www.kyoceraprecisiontools.com/locate. Prices Shown Valid in U.S. Only.

DRZ Toolholders (Ø0.562"~Ø2.000")



Choose (1) Drill Body and (10) Inserts

Choose your drill and insert grade.
 Promo Code: **KYO-DRZ-KIT**

2xD

Drill Description	Drill Dia.	Insert Description See Page 28	Grades (Pick 1)	Kit Option		
				Kit Insert Qty.	U.S. Kit Price	
S75-DRZ5621125-05G	0.562"	ZCMT050203	PR1230 Carbon Steel & Alloy Steel PR1225 Stainless Steel PR1210 Gray and Nodular Cast Iron KW10 Non-ferrous Metals	10	\$299.00	
S100-DRZ6251250-06G	0.625"	ZCMT06T204		10	\$309.00	
S100-DRZ6561312-06G	0.656"			10	\$309.00	
S100-DRZ6881375-06G	0.688"			10	\$309.00	
S100-DRZ7501500-06G	0.750"			10	\$309.00	
S100-DRZ8121625-06G	0.812"			10	\$309.00	
S100-DRZ8751750-08G	0.875"	ZCMT080304		10	\$309.00	
S100-DRZ9381875-08G	0.938"			10	\$309.00	
S100-DRZ10002000-08G	1.000"			10	\$349.00	
S100-DRZ10622125-10G	1.062"	ZCMT10T304		10	\$349.00	
S100-DRZ11252250-10G	1.125"			10	\$349.00	
S100-DRZ11882375-10G	1.188"			10	\$349.00	
S100-DRZ12502500-10G	1.250"			10	\$349.00	
S125-DRZ13122625-12G	1.312"	ZCMT12T306		10	\$349.00	
S125-DRZ13752750-12G	1.375"			10	\$349.00	
S125-DRZ14382875-12G	1.438"			10	\$349.00	
S125-DRZ15003000-12G	1.500"			10	\$349.00	
S125-DRZ15623125-12G	1.562"			10	\$419.00	
S125-DRZ16253250-15G	1.625"			ZCMT150408	10	\$419.00
S125-DRZ16883375-15G	1.688"				10	\$419.00
S125-DRZ17503500-15G	1.750"	10	\$419.00			
S125-DRZ18123625-15G	1.812"	10	\$419.00			
S125-DRZ18753750-15G	1.875"	10	\$419.00			
S125-DRZ19383875-15G	1.938"	10	\$419.00			
S125-DRZ20004000-15G	2.000"	10	\$419.00			

DRZ
Magic Drills
2xD

MILLING SOLUTIONS
TURNING SOLUTIONS
DRILLING SOLUTIONS
SOLID ROUND SOLUTIONS
TOOL HOLDING SOLUTIONS

DRZ Toolholders (Ø0.562"~Ø2.000")

Choose (1) Drill Body and (10) Inserts

Choose your drill and insert grade.
 Promo Code: **KYO-DRZ-KIT**



3xD

Drill Description	Drill Dia.	Insert Description See Page 28	Grades (Pick 1)	Kit Option	
				Kit Insert Qty.	U.S. Kit Price
S75-DRZ5621687-05G	0.562"	ZCMT050203	PR1230 Carbon Steel & Alloy Steel PR1225 Stainless Steel PR1210 Gray and Nodular Cast Iron KW10 Non-ferrous Metals	10	\$299.00
S100-DRZ6251875-06G	0.625"	ZCMT06T204		10	\$309.00
S100-DRZ6561969-06G	0.656"			10	\$309.00
S100-DRZ6882062-06G	0.688"			10	\$309.00
S100-DRZ7502250-06G	0.750"			10	\$309.00
S100-DRZ8122438-06G	0.812"			10	\$309.00
S100-DRZ8752625-08G	0.875"	ZCMT080304		10	\$309.00
S100-DRZ9382814-08G	0.938"			10	\$309.00
S100-DRZ10003000-08G	1.000"			10	\$349.00
S100-DRZ10623187-10G	1.062"	ZCMT10T304		10	\$349.00
S100-DRZ11253375-10G	1.125"			10	\$349.00
S100-DRZ11883562-10G	1.188"			10	\$349.00
S100-DRZ12503750-10G	1.250"			10	\$349.00
S125-DRZ13123938-12G	1.312"	ZCMT12T306		10	\$369.00
S125-DRZ13754125-12G	1.375"			10	\$369.00
S125-DRZ14384312-12G	1.438"			10	\$369.00
S125-DRZ15004500-12G	1.500"			10	\$369.00
S125-DRZ15624688-12G	1.562"			10	\$449.00
S125-DRZ16254875-15G	1.625"			ZCMT150408	10
S125-DRZ16885062-15G	1.688"	10			\$449.00
S125-DRZ17505250-15G	1.750"	10	\$449.00		
S125-DRZ18125438-15G	1.812"	10	\$449.00		
S125-DRZ18755625-15G	1.875"	10	\$449.00		
S125-DRZ19385812-15G	1.938"	10	\$449.00		
S125-DRZ20006000-15G	2.000"	10	\$449.00		

All 2017 Winter / Spring Offers Valid through June 30, 2017

All promo items are available exclusively through Authorized North American Kyocera Precision Tool Distributors. Please use specified Promo Code when placing orders.

To locate a distributor visit www.kyoceraprecisiontools.com/locate. Prices Shown Valid in U.S. Only.

MILLING SOLUTIONS

TURNING SOLUTIONS

DRILLING SOLUTIONS

SOLID ROUND SOLUTIONS

TOOL HOLDING SOLUTIONS

DRZ Toolholders (Ø13mm~Ø49mm)

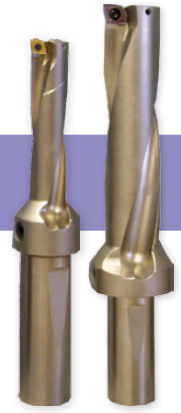

Choose (1) Drill Body and (10) Inserts

Choose your drill and insert grade.
 Promo Code: **KYO-DRZ-KIT**

3xD

Drill Description	Drill Dia.	Insert Description See ☺ Page 28	Grades (Pick 1)	Kit Option				
				Kit Insert Qty.	U.S. Kit Price			
DRZ Magic Drills 3xD Metric Diameter Inch Shank	S75-DRZ1339-05G	13.0mm	ZCMT050203	PR1230 Carbon Steel & Alloy Steel	10	\$309.00		
	S75-DRZ135405-05G	13.5mm			10	\$309.00		
	S75-DRZ1442-05G	14.0mm			10	\$309.00		
	S75-DRZ145435-05G	14.5mm			10	\$309.00		
	S75-DRZ1545-05G	15.0mm			10	\$309.00		
	S75-DRZ155465-05G	15.5mm			10	\$309.00		
	S100-DRZ1648-06G	16.0mm			10	\$309.00		
	S100-DRZ165495-06G	16.5mm			10	\$309.00		
	S100-DRZ1751-06G	17.0mm			10	\$309.00		
	S100-DRZ1854-06G	18.0mm			10	\$309.00		
	S100-DRZ185555-06G	18.5mm	ZCMT06T204	PR1225 Stainless Steel	10	\$309.00		
	S100-DRZ1957-06G	19.0mm			10	\$309.00		
	S100-DRZ195585-06G	19.5mm			10	\$309.00		
	S100-DRZ2060-06G	20.0mm			10	\$309.00		
	S100-DRZ2163-06G	21.0mm			10	\$309.00		
	S100-DRZ215645-08G	21.5mm			10	\$319.00		
	S100-DRZ2266-08G	22.0mm			10	\$319.00		
	S100-DRZ225675-08G	22.0mm			10	\$319.00		
	S100-DRZ2369-08G	23.0mm			ZCMT080304	PR1210 Gray and Nodular Cast Iron	10	\$319.00
	S100-DRZ2472-08G	24.0mm					10	\$319.00
	S100-DRZ2575-08G	25.0mm	10	\$319.00				
	S100-DRZ2678-08G	26.0mm	10	\$319.00				
	S100-DRZ2781-10G	27.0mm	10	\$349.00				
	S100-DRZ2884-10G	28.0mm	10	\$349.00				
	S100-DRZ2987-10G	29.0mm	10	\$349.00				
	S100-DRZ3090-10G	30.0mm	10	\$349.00				
	S100-DRZ3193-10G	31.0mm	10	\$349.00				
	S100-DRZ3296-10G	32.0mm	ZCMT10T304	KW10 Non-ferrous Metals			10	\$349.00
	S125-DRZ3399-12G	33.0mm			10	\$359.00		
	S125-DRZ34102-12G	34.0mm			10	\$349.00		
	S125-DRZ35105-12G	35.0mm			10	\$349.00		
	S125-DRZ36108-12G	36.0mm			10	\$349.00		
	S125-DRZ37111-12G	37.0mm			10	\$349.00		
	S125-DRZ38114-12G	38.0mm			10	\$349.00		
	S125-DRZ39117-12G	39.0mm			10	\$419.00		
	S125-DRZ40120-12G	40.0mm			10	\$419.00		
	S125-DRZ41123-15G	41.0mm			ZCMT12T306		10	\$419.00
	S125-DRZ42126-15G	42.0mm	10	\$419.00				
	S125-DRZ43129-15G	43.0mm	10	\$419.00				
	S125-DRZ44132-15G	44.0mm	10	\$419.00				
S125-DRZ45135-15G	45.0mm	10	\$419.00					
S125-DRZ46138-15G	46.0mm	10	\$419.00					
S125-DRZ47141-15G	47.0mm	10	\$419.00					
S125-DRZ48144-15G	48.0mm	10	\$419.00					
S125-DRZ49147-15G	49.0mm	ZCMT150408		10			\$419.00	
				10			\$419.00	

KYOCERA Precision Tools, Inc.

P: 800.823.7284 • F: 828.692.1344 • E: ctsales@kyocera.com
 Official Website | www.kyoceraprecisiontools.com

MILLING SOLUTIONS

TURNING SOLUTIONS

DRILLING SOLUTIONS

SOLID ROUND SOLUTIONS

TOOL HOLDING SOLUTIONS

DRZ Toolholders (Ø0.562"~Ø2.000")

Choose (1) Drill Body and (10) Inserts

Choose your drill and insert grade.
 Promo Code: **KYO-DRZ-KIT**

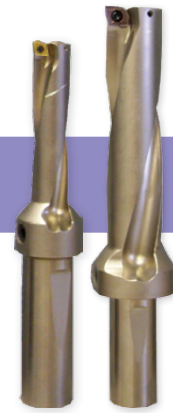

4xD

Drill Description	Drill Dia.	Insert Description See Page 28	Grades (Pick 1)	Kit Option		
				Kit Insert Qty.	U.S. Kit Price	
S75-DRZ5622250-05G	0.562"	ZCMT050203	PR1230 Carbon Steel & Alloy Steel PR1225 Stainless Steel PR1210 Gray and Nodular Cast Iron KW10 Non-ferrous Metals	10	\$319.00	
S100-DRZ6252500-06G	0.625"	ZCMT06T204		10	\$319.00	
S100-DRZ6882750-06G	0.688"			10	\$319.00	
S100-DRZ7503000-06G	0.750"			10	\$319.00	
S100-DRZ8123250-06G	0.812"			10	\$319.00	
S100-DRZ8753500-08G	0.875"			ZCMT080304	10	\$319.00
S100-DRZ9383750-08G	0.938"	10			\$319.00	
S100-DRZ10004000-08G	1.000"	10			\$319.00	
S125-DRZ10624250-10G	1.062"	ZCMT10T304		10	\$369.00	
S125-DRZ11254500-10G	1.125"			10	\$369.00	
S125-DRZ11884750-10G	1.188"			10	\$369.00	
S125-DRZ12505000-10G	1.250"			10	\$369.00	
S125-DRZ13125250-12G	1.312"			ZCMT12T306	10	\$369.00
S125-DRZ13755500-12G	1.375"	10			\$369.00	
S125-DRZ14385750-12G	1.438"	10			\$369.00	
S125-DRZ15006000-12G	1.500"	10			\$369.00	
S125-DRZ15626250-12G	1.562"	10			\$369.00	
S125-DRZ16256500-15G	1.625"	ZCMT150408			10	\$419.00
S150-DRZ16886750-15G	1.688"				10	\$419.00
S150-DRZ17507000-15G	1.750"			10	\$419.00	
S150-DRZ18127250-15G	1.812"		10	\$419.00		
S150-DRZ18757500-15G	1.875"		10	\$419.00		
S150-DRZ19387750-15G	1.938"		10	\$419.00		
S150-DRZ20008000-15G	2.000"		10	\$419.00		

All 2017 Winter / Spring Offers Valid through June 30, 2017

All promo items are available exclusively through Authorized North American Kyocera Precision Tool Distributors. Please use specified Promo Code when placing orders.

To locate a distributor visit www.kyoceraprecisiontools.com/locate. Prices Shown Valid in U.S. Only.

MILLING SOLUTIONS
 TURNING SOLUTIONS
 DRILLING SOLUTIONS
 SOLID ROUND SOLUTIONS
 TOOL HOLDING SOLUTIONS

DRZ Toolholders (Ø1.062" ~ Ø2.000")

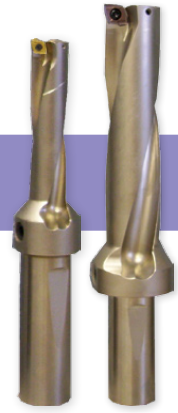

Choose (1) Drill Body and (10) Inserts

Choose your drill and insert grade.
 Promo Code: **KYO-DRZ-KIT**

5xD

Drill Description	Drill Dia.	Insert Description See Page 28	Grades (Pick 1)	Kit Option		
				Kit Insert Qty.	U.S. Kit Price	
DRZ Magic Drills 5xD	S125-DRZ10625310-10G	1.062"	ZCMT10T304	PR1230 Carbon Steel & Alloy Steel PR1225 Stainless Steel PR1210 Gray and Nodular Cast Iron KW10 Non-ferrous Metals	10	\$419
	S125-DRZ11255625-10G	1.125"			10	\$419
	S125-DRZ11885940-10G	1.188"			10	\$419
	S125-DRZ12506250-10G	1.250"			10	\$419
	S125-DRZ13126560-12G	1.312"	ZCMT12T306		10	\$449
	S125-DRZ13756875-12G	1.375"			10	\$449
	S125-DRZ14387190-12G	1.438"			10	\$449
	S125-DRZ15007500-12G	1.500"			10	\$449
	S125-DRZ15627810-12G	1.562"	ZCMT150408		10	\$449
	S125-DRZ16258125-15G	1.625"			10	\$459
	S150-DRZ16888440-15G	1.188"			10	\$459
	S150-DRZ17508750-15G	1.750"			10	\$459
	S150-DRZ18129060-15G	1.812"	10		\$459	
	S150-DRZ18759375-15G	1.875"	10		\$459	
	S150-DRZ19389690-15G	1.938"	10		\$459	
	S150-DRZ200010000-15G	2.000"	10		\$459	

MILLING SOLUTIONS

TURNING SOLUTIONS

DRILLING SOLUTIONS

SOLID ROUND SOLUTIONS

TOOL HOLDING SOLUTIONS

HOLESHOT™ Kits

DR Indexable Drills

Optimized Flute Design

Maximum rigidity and good chip evacuation

Patented Swept Back Design

Enables drilling of stacked plates and welded assemblies

Excellent Chip Control

Reduces slug formation with superior chip control



Patented Swept Back Design



MILLING SOLUTIONS

TURNING SOLUTIONS

DRILLING SOLUTIONS

SOLID ROUND SOLUTIONS

TOOL HOLDING SOLUTIONS

HOLESHOT Drill Inserts

Usage Classification	P	Carbon Steel / Alloy Steel		★			
		Mold Steel		★			
★ 1st Choice ☆ 2nd Choice	M	Stainless Steel		☆			
	K	Gray Cast Iron					
		Ductile Cast Iron					
Insert	Part Number	Dimensions (in)				Angle	MEGACOAT
		A	T	Ød	rε	α	PR1230
	WCMX 040204-M1A	1/4	0.094	0.110	1/64	7°	●
	050308-M1	5/16	1/8	0.125	1/32		●
	050308-M1A	5/16	1/8	0.125	1/32		●
	06T308-M1	3/8	5/32	0.146	1/32		●
	06T308-M1A	3/8	5/32	0.146	1/32		●

WCMX...M1 : General purpose drilling insert. First choice for medium-high carbon steel, tool steels, and cast iron. Tougher edge than **M1A** chipbreaker.

WCMX...M1A : First choice for low-carbon steel and other "sticky" materials. Freer cutting than **M1** chipbreaker

● : U.S. Stock

All 2017 Winter / Spring Offers Valid through June 30, 2017

All promo items are available exclusively through Authorized North American Kyocera Precision Tool Distributors. Please use specified Promo Code when placing orders.

To locate a distributor visit www.kyoceraprecisiontools.com/locate. Prices Shown Valid in U.S. Only.

HOLESHOT™ (Ø0.688"~Ø1.125")



Choose (1) Drill Body and (10) Inserts

Choose your drill and insert.
 Promo Code: **KYO-DR-KIT**

Drill Description	Drill Dia.	Insert Description (Pick 1) See Page 34	Grades (Pick 1)	Kit Option	
				Kit Insert Qty.	U.S. Kit Price
Drill Diameter 0.688"~1.125"	DR-0688-X3N	0.688"	WCMX040204M1A	10	\$249.00
	DR-0709-X3N	0.709" (18mm)		10	\$249.00
	DR-0719-X3N	0.719"		10	\$249.00
	DR-0750-X3N	0.750"		10	\$269.00
	DR-0781-X3N	0.781"		10	\$269.00
	DR-0787-X3N	0.787" (20mm)		10	\$269.00
	DR-0813-X3N	0.813"		10	\$269.00
	DR-0827-X3N	0.827" (21mm)		10	\$269.00
	DR-0844-X3N	0.844"		10	\$269.00
	DR-0866	0.866" (22mm)		10	\$279.00
	DR-0866-X3N	0.866" (22mm)		10	\$309.00
	DR-0875	0.875"		10	\$279.00
	DR-0875-X3N	0.875"		10	\$309.00
	DR-0906	0.906" (23mm)		10	\$279.00
	DR-0906-X3N	0.906" (23mm)		10	\$309.00
	DR-0937	0.937"		10	\$279.00
	DR-0937-X3N	0.937"		10	\$309.00
	DR-0945	0.945" (24mm)		10	\$279.00
	DR-0945-X3N	0.945" (24mm)	10	\$309.00	
	DR-0969	0.969"	10	\$279.00	
	DR-0969-X3N	0.969"	10	\$309.00	
	DR-0984	0.984" (25mm)	10	\$279.00	
	DR-0984-X3N	0.984" (25mm)	10	\$309.00	
	DR-1000	1.000"	10	\$279.00	
	DR-1000-X3N	1.000"	10	\$309.00	
	DR-1024	1.024" (26mm)	10	\$279.00	
	DR-1024-X3N	1.024" (26mm)	10	\$309.00	
	DR-1031	1.031"	10	\$349.00	
	DR-1031-X3N	1.031"	10	\$369.00	
	DR-1062	1.062" (27mm)	10	\$349.00	
	DR-1062-X3N	1.062" (27mm)	10	\$369.00	
	DR-1094	1.094"	10	\$349.00	
	DR-1094-X3N	1.094"	10	\$369.00	
	DR-1102	1.102" (28mm)	10	\$349.00	
DR-1102-X3N	1.102" (28mm)	10	\$369.00		
DR-1125	1.125"	10	\$349.00		
DR-1125-X3N	1.125"	10	\$369.00		
		WCMX050308M1 WCMX050308M1A	PR1230 Carbon Steel & Alloy Steel		

MILLING SOLUTIONS

TURNING SOLUTIONS

DRILLING SOLUTIONS

SOLID ROUND SOLUTIONS

TOOL HOLDING SOLUTIONS

HOLESHOT™ (Ø1.142"~Ø1.406")

Choose (1) Drill Body and (10) Inserts

Choose your drill and insert.
 Promo Code: **KYO-DR-KIT**



MILLING SOLUTIONS

TURNING SOLUTIONS

DRILLING SOLUTIONS

SOLID ROUND SOLUTIONS

TOOL HOLDING SOLUTIONS

Drill Description	Drill Dia.	Insert Description (Pick 1) See Page 34	Grades (Pick 1)	Kit Option	
				Kit Insert Qty.	U.S. Kit Price
DR-1142	1.142" (29mm)	WCMX050308M1 WCMX050308M1A	PR1230 Carbon Steel & Alloy Steel	10	\$349.00
DR-1142-X3N	1.142" (29mm)			10	\$369.00
DR-1156	1.156"			10	\$349.00
DR-1156-X3N	1.156"			10	\$369.00
DR-1181	1.181" (30mm)	WCMX06T308M1 WCMX06T308M1A		10	\$349.00
DR-1181-X3N	1.181" (30mm)			10	\$369.00
DR-1187	1.187"			10	\$349.00
DR-1187-X3N	1.187"			10	\$369.00
DR-1219	1.219"			10	\$349.00
DR-1219-X3N	1.219"			10	\$369.00
DR-1250	1.250"			10	\$349.00
DR-1250-X3N	1.250"			10	\$369.00
DR-1260	1.260" (32mm)			10	\$349.00
DR-1260-X3N	1.260" (32mm)			10	\$369.00
DR-1281	1.281"	WCMX06T308M1 WCMX06T308M1A		10	\$349.00
DR-1281-X3N	1.281"			10	\$369.00
DR-1299	1.299" (33mm)			10	\$349.00
DR-1299-X3N	1.299" (33mm)			10	\$369.00
DR-1312	1.312"			10	\$349.00
DR-1312-X3N	1.312"			10	\$369.00
DR-1339	1.339" (34mm)		10	\$349.00	
DR-1339-X3N	1.339" (34mm)		10	\$369.00	
DR-1344	1.344"		10	\$349.00	
DR-1344-X3N	1.344"		10	\$369.00	
DR-1375	1.375"	WCMX06T308M1 WCMX06T308M1A	10	\$349.00	
DR-1375-X3N	1.375"		10	\$369.00	
DR-1406	1.406"		10	\$389.00	
DR-1406-X3N	1.406"		10	\$399.00	

Drill Diameter
1.142"~1.406"

All 2017 Winter / Spring Offers Valid through June 30, 2017

All promo items are available exclusively through Authorized North American Kyocera Precision Tool Distributors. Please use specified Promo Code when placing orders.

To locate a distributor visit www.kyoceraprecisiontools.com/locate. Prices Shown Valid in U.S. Only.

HOLESHOT™ (Ø1.417"~Ø1.687")

Choose (1) Drill Body and (10) Inserts

Choose your drill and insert.
 Promo Code: **KYO-DR-KIT**



MILLING SOLUTIONS

TURNING SOLUTIONS

DRILLING SOLUTIONS

SOLID ROUND SOLUTIONS

TOOL HOLDING SOLUTIONS

Drill Description	Drill Dia.	Insert Description (Pick 1) See Page 34	Grades (Pick 1)	Kit Option	
				Kit Insert Qty.	U.S. Kit Price
DR-1417	1.417" (36mm)	WCMX06T308M1 WCMX06T308M1A	PR1230 Carbon Steel & Alloy Steel	10	\$389.00
DR-1417-X3N	1.417" (36mm)			10	\$399.00
DR-1437	1.437"			10	\$389.00
DR-1437-X3N	1.437"			10	\$399.00
DR-1457	1.457" (37mm)			10	\$389.00
DR-1457-X3N	1.457" (37mm)			10	\$399.00
DR-1469	1.469"			10	\$389.00
DR-1469-X3N	1.469"			10	\$399.00
DR-1496	1.496" (38mm)			10	\$389.00
DR-1496-X3N	1.496" (38mm)			10	\$399.00
DR-1500	1.500"			10	\$389.00
DR-1500-X3N	1.500"			10	\$399.00
DR-1531	1.531"			10	\$399.00
DR-1531-X3N	1.531"			10	\$429.00
DR-1535-X3N	1.535" (39mm)			10	\$429.00
DR-1562	1.562"			10	\$399.00
DR-1562-X3N	1.562"			10	\$429.00
DR-1575	1.575" (40mm)			WCMX050308M1 WCMX050308M1A	10
DR-1575-X3N	1.575" (40mm)	10	\$429.00		
DR-1594	1.594"	10	\$399.00		
DR-1594-X3N	1.594"	10	\$429.00		
DR-1614	1.614" (41mm)	10	\$399.00		
DR-1614-X3N	1.614" (41mm)	10	\$429.00		
DR-1625	1.625"	10	\$399.00		
DR1625-X3N	1.625"	10	\$429.00		
DR-1656	1.656"	10	\$399.00		
DR-1656-X3N	1.656"	10	\$429.00		
DR-1687	1.687"	10	\$399.00		
DR-1687-X3N	1.687"	10	\$429.00		

Drill Diameter
1.417"~1.687"

KYOCERA Precision Tools, Inc.

P: 800.823.7284 • F: 828.692.1344 • E: ctsales@kyocera.com
 Official Website | www.kyoceraprecisiontools.com

HOLESHOT™ (Ø1.693"~Ø1.969")

Choose (1) Drill Body and (10) Inserts

Choose your drill and insert.
 Promo Code: **KYO-DR-KIT**



MILLING SOLUTIONS

TURNING SOLUTIONS

DRILLING SOLUTIONS

SOLID ROUND SOLUTIONS

TOOL HOLDING SOLUTIONS

Drill Description	Drill Dia.	Insert Description (Pick 1) See Page 34	Grades (Pick 1)	Kit Option	
				Kit Insert Qty.	U.S. Kit Price
DR-1693	1.693" (43mm)	WCMX050308M1 WCMX050308M1A	PR1230 Carbon Steel & Alloy Steel	10	\$419.00
DR-1693-X3N	1.693" (43mm)			10	\$449.00
DR-1719	1.719"			10	\$419.00
DR-1719-X3N	1.719"			10	\$449.00
DR-1732	1.732" (44mm)			10	\$419.00
DR-1732-X3N	1.732" (44mm)			10	\$449.00
DR-1750	1.750"			10	\$419.00
DR-1750-X3N	1.750"			10	\$449.00
DR-1772	1.772" (45mm)			10	\$419.00
DR-1772-X3N	1.772" (45mm)			10	\$449.00
DR-1781	1.781"			10	\$419.00
DR-1781-X3N	1.781"			10	\$449.00
DR-1812	1.812"			10	\$419.00
DR-1812-X3N	1.812"			10	\$449.00
DR-1844	1.844"			10	\$439.00
DR-1844-X3N	1.844"			10	\$469.00
DR-1850	1.850" (47mm)			10	\$439.00
DR-1850-X3N	1.850" (47mm)			10	\$469.00
DR-1875	1.875"			10	\$439.00
DR-1875-X3N	1.875"			10	\$469.00
DR-1890-X3N	1.890"			10	\$439.00
DR-1906	1.906"			10	\$469.00
DR-1906-X3N	1.906"			10	\$439.00
DR-1929	1.929" (49mm)			10	\$469.00
DR-1929-X3N	1.929" (49mm)			10	\$439.00
DR-1937	1.937"			10	\$469.00
DR-1937-X3N	1.937"			10	\$439.00
DR-1969	1.969" (50mm)			10	\$469.00
DR-1969-X3N	1.969" (50mm)	10	\$439.00		

Drill Diameter
1.693" ~ 1.969"

All 2017 Winter / Spring Offers Valid through June 30, 2017

All promo items are available exclusively through Authorized North American Kyocera Precision Tool Distributors. Please use specified Promo Code when placing orders.

To locate a distributor visit www.kyoceraprecisiontools.com/locate. Prices Shown Valid in U.S. Only.

HOLESHOT™ (Ø2.000"~Ø2.219")



Choose (1) Drill Body and (10) Inserts

Choose your drill and insert.
 Promo Code: **KYO-DR-KIT**

Drill Description	Drill Dia.	Insert Description (Pick 1) See Page 34	Grades (Pick 1)	Kit Option		
				Kit Insert Qty.	U.S. Kit Price	
Drill Diameter 2.000"~2.219"	DR-2000	2.000"	PR1230 Carbon Steel & Alloy Steel	10	\$469.00	
	DR-2000-X1	2.000"		10	\$439.00	
	DR-2000-X3N	2.000"		10	\$469.00	
	DR-2008	2.008" (51mm)		WCMX050308M1 WCMX050308M1A	10	\$439.00
	DR-2008-X3N	2.008" (51mm)			10	\$469.00
	DR-2031	2.031"		WCMX06T308M1 WCMX06T308M1A	10	\$479.00
	DR-2031-X1	2.031"			10	\$479.00
	DR-2031-X3N	2.031"			10	\$479.00
	DR-2047	2.047" (52mm)		WCMX06T308M1 WCMX06T308M1A	10	\$459.00
	DR-2047-X3N	2.047" (52mm)			10	\$489.00
	DR-2062	2.062"		WCMX06T308M1 WCMX06T308M1A	10	\$459.00
	DR-2062-X1	2.062"			10	\$459.00
	DR-2062-X3N	2.062"			10	\$489.00
	DR-2094	2.094"		WCMX06T308M1 WCMX06T308M1A	10	\$459.00
	DR-2094-X1	2.094"			10	\$459.00
	DR-2094-X3N	2.094"			10	\$489.00
	DR-2125	2.125" (54mm)		WCMX06T308M1 WCMX06T308M1A	10	\$459.00
	DR-2125-X1	2.125" (54mm)	10		\$459.00	
	DR-2125-X3N	2.125" (54mm)	10		\$489.00	
	DR-2156	2.156"	WCMX06T308M1 WCMX06T308M1A	10	\$479.00	
	DR-2156-X1	2.156"		10	\$519.00	
	DR-2156-X3N	2.156"		10	\$479.00	
	DR-2187	2.187"	WCMX06T308M1 WCMX06T308M1A	10	\$519.00	
	DR-2187-X1	2.187"		10	\$479.00	
	DR-2187-X3N	2.187"		10	\$519.00	
	DR-2205	2.205" (56mm)	WCMX06T308M1 WCMX06T308M1A	10	\$479.00	
	DR-2205-X3N	2.205" (56mm)		10	\$519.00	
	DR-2219	2.219"	WCMX06T308M1 WCMX06T308M1A	10	\$479.00	
	DR-2219-X1	2.219"		10	\$479.00	
	DR-2219-X3N	2.219"		10	\$519.00	

MILLING SOLUTIONS

TURNING SOLUTIONS

DRILLING SOLUTIONS

SOLID ROUND SOLUTIONS

TOOL HOLDING SOLUTIONS

HOLESHOT™ (Ø2.244"~Ø2.480")

Choose (1) Drill Body and (10) Inserts

Choose your drill and insert.
 Promo Code: **KYO-DR-KIT**



MILLING SOLUTIONS

TURNING SOLUTIONS

DRILLING SOLUTIONS

SOLID ROUND SOLUTIONS

TOOL HOLDING SOLUTIONS

Drill Description	Drill Dia.	Insert Description (Pick 1) See Page 34	Grades (Pick 1)	Kit Option	
				Kit Insert Qty.	U.S. Kit Price
DR-2244	2.244" (57mm)	WCMX06T308M1 WCMX06T308M1A	PR1230 Carbon Steel & Alloy Steel	10	\$499.00
DR-2244-X3N	2.244" (57mm)			10	\$529.00
DR-2250	2.250"			10	\$499.00
DR-2250-X1	2.250"			10	\$499.00
DR-2250-X3N	2.250"			10	\$529.00
DR-2281	2.281"			10	\$499.00
DR-2281-X1	2.281"			10	\$499.00
DR-2281-X3N	2.281"			10	\$529.00
DR-2312	2.312"			10	\$499.00
DR-2312-X1	2.312"			10	\$499.00
DR-2312-X3N	2.312"			10	\$529.00
DR-2323	2.323" (59mm)			10	\$499.00
DR-2344	2.344"			10	\$499.00
DR-2344-X1	2.344"			10	\$499.00
DR-2344-X3N	2.344"			10	\$529.00
DR-2362	2.362" (60mm)			10	\$499.00
DR-2362-X3N	2.362" (60mm)			10	\$529.00
DR-2375	2.375"			10	\$499.00
DR-2375-X1	2.375"			10	\$499.00
DR-2375-X3N	2.375"			10	\$529.00
DR-2406	2.406"			10	\$499.00
DR-2406-X1	2.406"			10	\$499.00
DR-2406-X3N	2.406"			10	\$529.00
DR-2437	2.437"			10	\$499.00
DR-2437-X1	2.437"			10	\$499.00
DR-2437-X3N	2.437"			10	\$529.00
DR-2441	2.441" (62mm)			10	\$499.00
DR-2441-X3N	2.441" (62mm)			10	\$529.00
DR-2469	2.469"			10	\$499.00
DR-2469-X1	2.469"			10	\$499.00
DR-2469-X3N	2.469"	10	\$529.00		
DR-2480	2.480" (63mm)	10	\$499.00		
DR-2480-X3N	2.480" (63mm)	10	\$529.00		

Drill Diameter
2.244"~2.480"

All 2017 Winter / Spring Offers Valid through June 30, 2017

All promo items are available exclusively through Authorized North American Kyocera Precision Tool Distributors. Please use specified Promo Code when placing orders.

To locate a distributor visit www.kyoceraprecisiontools.com/locate. Prices Shown Valid in U.S. Only.

HOLESHOT™ (Ø2.500"~Ø4.000")



Choose (1) Drill Body and (10) Inserts

Choose your drill and insert.
 Promo Code: **KYO-DR-KIT**

Drill Description	Drill Dia.	Insert Description (Pick 1) See Page 34	Grades (Pick 1)	Kit Option	
				Kit Insert Qty.	U.S. Kit Price
DR-2500	2.500"	WCMX06T308M1 WCMX06T308M1A	PR1230 Carbon Steel & Alloy Steel	10	\$499.00
DR-2500-X1	2.500"			10	\$499.00
DR-2500-X3N	2.500"			10	\$529.00
DR-2625	2.625"			10	\$569.00
DR-2625-X1	2.656"			10	\$569.00
DR-2750	2.750"			10	\$649.00
DR-2750-X1	2.750"			10	\$649.00
DR-2875	2.875"			10	\$669.00
DR-2875-X1	2.875"			10	\$669.00
DR-3000	3.000"			10	\$699.00
DR-3000-X1	3.000"			10	\$699.00
DR-3125	3.125"			10	\$699.00
DR-3125-X1	3.125"			10	\$699.00
DR-3250	3.250"			10	\$699.00
DR-3250-X1	3.250"			10	\$699.00
DR-3375	3.375"			10	\$789.00
DR-3375-X1	3.375"			10	\$789.00
DR-3500	3.500"			10	\$789.00
DR-3500-X1	3.500"			10	\$789.00
DR-3625	3.625"			10	\$809.00
DR-3625-X1	3.625"			10	\$809.00
DR-3750	3.750"			10	\$849.00
DR-3750-X1	3.750"			10	\$849.00
DR-3875	3.875"			10	\$849.00
DR-3875-X1	3.875"			10	\$849.00
DR-4000	4.000"			10	\$899.00
DR-4000-X1	4.000"			10	\$899.00

Drill Diameter
2.500"~4.000"

MILLING SOLUTIONS

TURNING SOLUTIONS

DRILLING SOLUTIONS

SOLID ROUND SOLUTIONS

TOOL HOLDING SOLUTIONS



VULCAN Compression End Mills

Unique Compression Design for Routing Composites

Used in the automotive and aerospace industries, composite layer materials are dense and abrasive by nature and require unique tools like the compression end mill to create clean edges and surface finish.

BUY 1, GET 1 50% OFF
of Equal or Lesser Value

Mix-and-match among sizes!
Promo Code: **KYO-VULCAN**

MILLING SOLUTIONS

TURNING SOLUTIONS

DRILLING SOLUTIONS

SOLID ROUND SOLUTIONS

TOOL HOLDING SOLUTIONS

1 Compression of Cutting Forces and Chip Flow

The compression end mill is designed with up cut and down cut flutes to compress the composite material preventing delamination. The spiral flute design creates a shearing action to cleanly cut the fibers. Utilizing a positive rake angle, the compression end mill makes quick sharp cuts minimizing heat and preventing the formation of resin burrs.

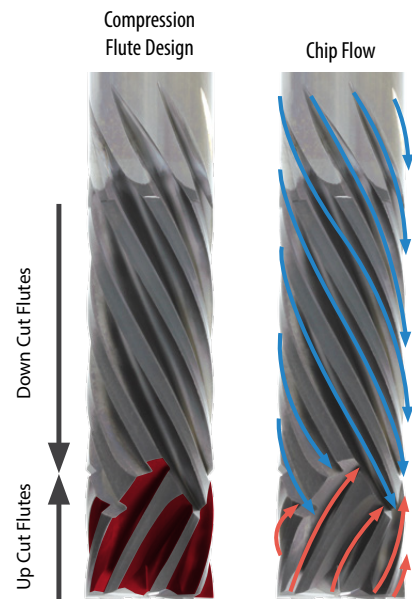
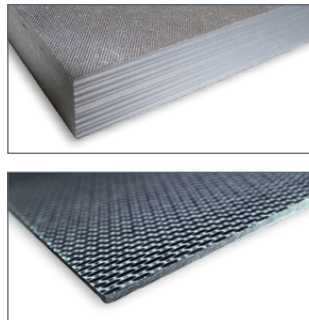
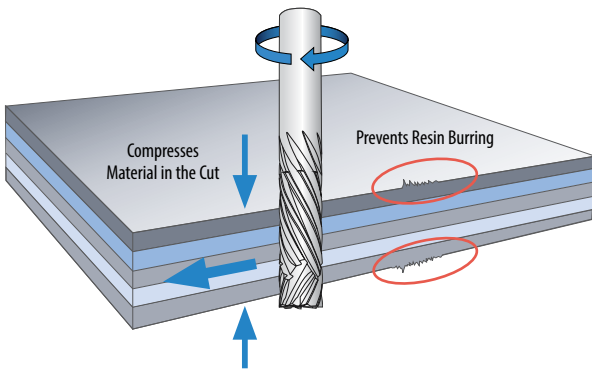

2 CVD Diamond Coating to Withstand Highly Abrasive Material

Utilizes strong CVD Diamond Coating for improving wear resistance and maintaining sharp cutting edges.

- CVD Diamond (Real Diamond)
- Thick Coating of 0.0006" (0.015mm)
- Smooth Surface for Efficient Coverage of the Coating



All 2017 Winter / Spring Offers Valid through June 30, 2017

All promo items are available exclusively through Authorized North American Kyocera Precision Tool Distributors. Please use specified Promo Code when placing orders.

To locate a distributor visit www.kyoceraprecisiontools.com/locate. Prices Shown Valid in U.S. Only.

VULCAN - Series 1890 Compression End Mills

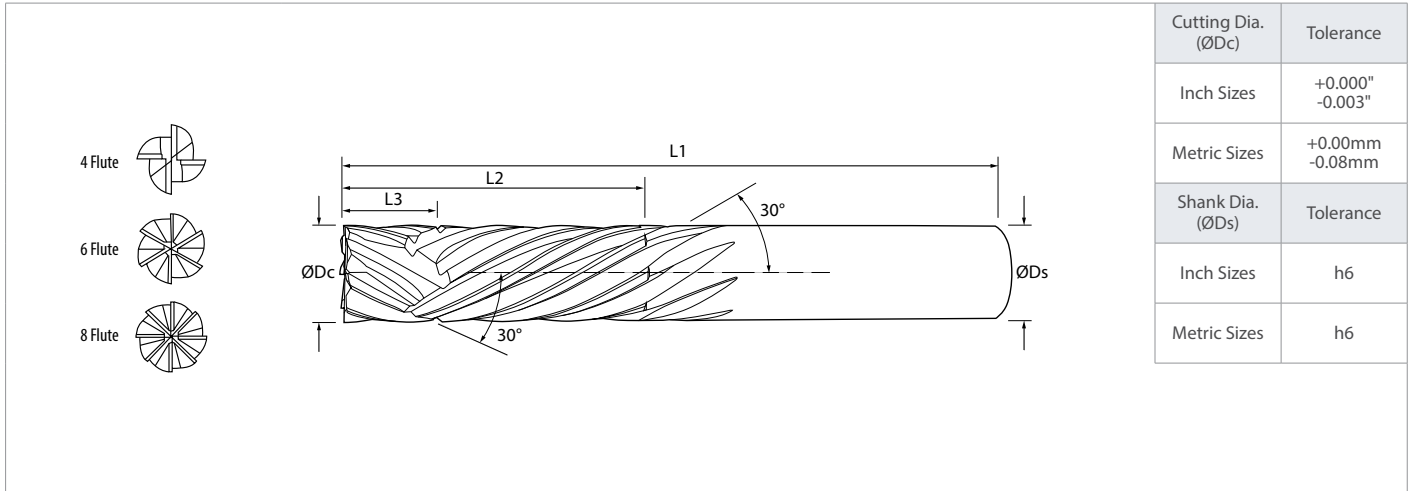

Tool Dimensions (Inch Sizes)

Part Number	Stock	Dimensions (in)					No. of Flutes
		ØDc	ØDs	L1	*L2	L3	
1890-2500V1000	●	1/4	1/4	2 1/2	1	0.175	4
1890-3125V1000	●	5/16	5/16	2 1/2	1	0.220	4
1890-3750V1125	●	3/8	3/8	2 1/2	1 1/8	0.265	6
1890-5000V1500	●	1/2	1/2	3 1/2	1 1/2	0.360	8

*L2 dimensions refers to the length of cut.

Tool Dimensions (Metric Sizes)

Part Number	Stock	Dimensions (mm)					No. of Flutes
		ØDc	ØDs	L1	*L2	L3	
1890-2362V709	●	6	6	63	25	4.10	4
1890-3150V984	●	8	8	63	25	5.58	4
1890-3937V984	●	10	10	63	28	7.05	6
1890-4724V1496	●	12	12	89	38	8.60	8

*L2 dimensions refers to the length of cut.

● : U.S. Stock

CAT40

Face Mill Toolholders

Promo Code: **KYO-CAT**

- Made from 8620 Alloy Steel
- Concentricity is less than .0002 at face and arbor
- All critical surfaces are precision ground
- Case hardened to 54-58 RC
- Case depth is .03-.04
- Balanced to G2.5 @ 20,000 rpm
- Rear thread for pull stud is 5/8-11
- Coolant through capable

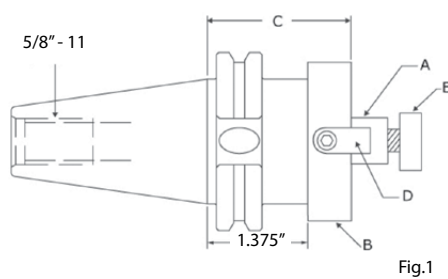

Fig.1

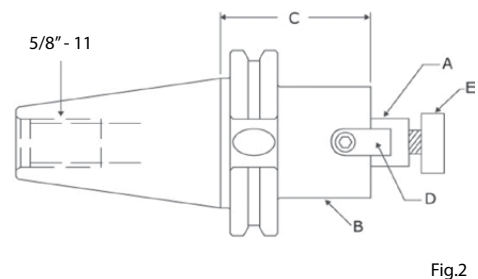

Fig.2

CAT40 Face Mill Holders

Part Number	Stock	Dimensions (in)						U.S. Promo Price
		Arbor Dia. (A)	O.D. (B)	Gage Length (C)	Key Width (D)	Screw (E)	Drawing	
KYO-CAT40- FM.75-2.0	●	0.750	1.750	2.000	5/16	3/8-24	2	\$129.00
FM1.0-2.0	●	1.000	2.180	2.000	3/8	1/2-20	1	\$129.00
FM1.25-2.0	●	1.250	2.440	2.000	1/2	5/8-18	1	\$129.00
FM1.5-2.0	●	1.500	2.520	2.000	5/8	3/4-16	1	\$129.00

All 2017 Winter / Spring Offers Valid through June 30, 2017

All promo items are available exclusively through Authorized North American Kyocera Precision Tool Distributors. Please use specified Promo Code when placing orders.

To locate a distributor visit www.kyoceraprecisiontools.com/locate. Prices Shown Valid in U.S. Only.

CAT40

End Mill Toolholders

Promo Code: **KYO-CAT**

- Made from 8620 Alloy Steel
- All critical surfaces are precision ground
- Case hardened to 56-58 RC
- Case depth is .03-.04
- Balanced to G2.5 @ 20,000 rpm
- Concentricity is .0001 or less
- Rear thread for pull stud is 5/8-11
- Coolant through capable

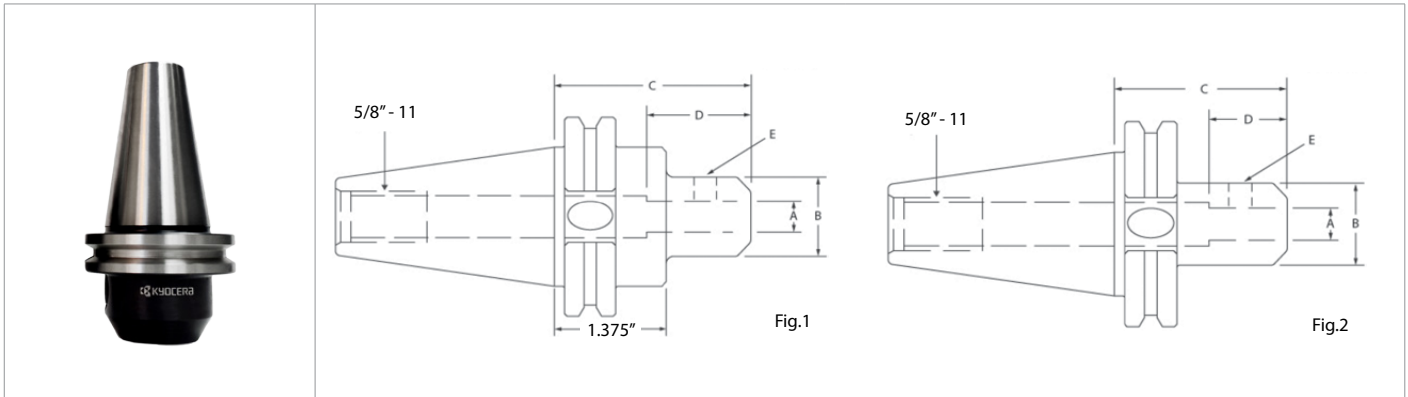

CAT40 End Mill Holders

Part Number	Stock	Dimensions (in)						U.S. Promo Price
		I.D. (A)	O.D. (B)	Gage Length (C)	Tool Depth (D)	Set Screw (E)	Drawing	
KYO-CAT40- EM.500-1.75	●	0.500	1.375	1.750	N/A	7/16-20	2	\$89.00
EM.625-1.75	●	0.625	1.500	1.750	2.100	9/16-18	2	\$89.00
EM.75-1.75	●	0.750	1.750	1.750	2.500	5/8-18	2	\$89.00
EM1.0-1.75	●	1.000	1.750	1.750	2.600	5/8-18	2	\$89.00
EM1.25-2.5	●	1.250	2.500	2.500	2.750	3/4-16	1	\$89.00
EM1.5-4.0	●	1.500	2.620	4.000	3.000	2x - 3/4-16	2*	\$119.00

* This tool holder does not have a safety zone for the tool changer. Although most machines do not require a safety zone, please be sure to check your machine tool requirements.

KYOCERA Precision Tools, Inc.

P: 800.823.7284 • F: 828.692.1344 • E: ctsales@kyocera.com
 Official Website | www.kyoceraprecisiontools.com

MILLING SOLUTIONS

TURNING SOLUTIONS

DRILLING SOLUTIONS

SOLID ROUND SOLUTIONS

TOOL HOLDING SOLUTIONS

CAT50

Face Mill Toolholders

Promo Code: **KYO-CAT**

- Made from 8620 Alloy Steel
- Concentricity is less than .0002 at face and arbor
- All critical surfaces are precision ground
- Case hardened to 54-58 RC
- Case depth is .03-.04
- Balanced to G2.5 @ 20,000 rpm
- Rear thread for pull stud is 1" x 8
- Coolant through capable

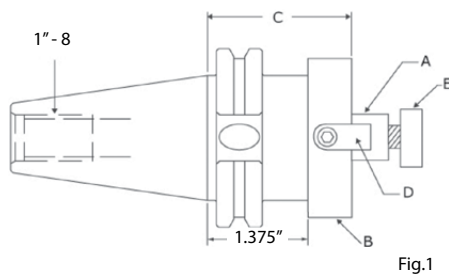

Fig.1

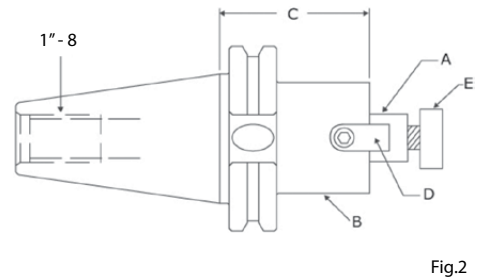

Fig.2

CAT50 Face Mill Holders

Part Number	Stock	Dimensions (in)						U.S. Promo Price
		Arbor Dia. (A)	O.D. (B)	Gage Length (C)	Key Width (D)	Screw (E)	Drawing	
KYO-CAT50- FM.75-3.0	●	0.750	1.750	3.000	5/16	3/8-24	2	\$149.00
FM1.0-3.0	●	1.000	2.180	3.000	3/8	1/2-20	2	\$149.00
FM1.25-3.0	●	1.250	2.440	3.000	1/2	5/8-18	2	\$149.00
FM1.5-3.0	●	1.500	2.740	3.000	5/8	3/4-16	2	\$149.00
FM2.0-3.0	●	2.000	3.700	3.000	3/4	1-14	1	\$209.00
FM2.5-3.0	●	2.500	4.000	3.000	1.0	1-14	1	\$209.00

All 2017 Winter / Spring Offers Valid through June 30, 2017

All promo items are available exclusively through Authorized North American Kyocera Precision Tool Distributors. Please use specified Promo Code when placing orders.

To locate a distributor visit www.kyoceraprecisiontools.com/locate. Prices Shown Valid in U.S. Only.

MILLING SOLUTIONS

TURNING SOLUTIONS

DRILLING SOLUTIONS

SOLID ROUND SOLUTIONS

TOOL HOLDING SOLUTIONS

CAT50

End Mill Toolholders

Promo Code: **KYO-CAT**

- Made from 8620 Alloy Steel
- All critical surfaces are precision ground
- Case hardened to 56-58 RC
- Case depth is .03-.04
- Balanced to G2.5 @ 20,000 rpm
- Concentricity is .0002 or less
- Rear thread for pull stud is 1" x 8
- Coolant through capable

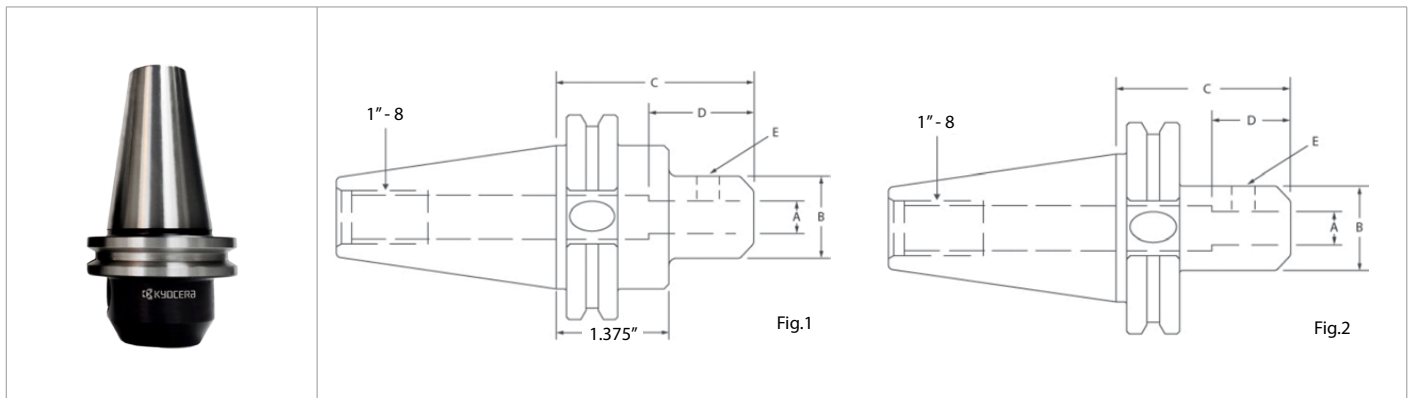

CAT50 End Mill Holders

Part Number	Stock	Dimensions (in)						U.S. Promo Price
		I.D. (A)	O.D. (B)	Gage Length (C)	Tool Depth (D)	Set Screw (E)	Drawing	
KYO-CAT50- EM.500-3.0	●	0.500	1.375	3.000	N/A	7/16-20	1	\$149.00
EM.625-3.0	●	0.625	1.500	3.000	N/A	9/16-18	1	\$149.00
EM.75-3.0	●	0.750	1.750	3.000	N/A	5/8-18	1	\$149.00
EM1.0-4.0	●	1.000	1.900	4.000	2.750	5/8-18	1	\$159.00
EM1.25-4.0	●	1.250	2.500	4.000	2.750	3/4-16	1	\$159.00
EM1.5-4.5	●	1.500	2.750	4.500	3.000	2x - 3/4-16	1	\$169.00
EM2.0-5.0	●	2.000	3.500	5.000	3.500	2x - 1.0-14	2*	\$189.00

* This tool holder does not have a safety zone for the tool changer. Although most machines do not require a safety zone, please be sure to check your machine tool requirements.

KYOCERA Precision Tools, Inc.

P: 800.823.7284 • F: 828.692.1344 • E: ctsales@kyocera.com
 Official Website | www.kyoceraprecisiontools.com

MILLING SOLUTIONS

TURNING SOLUTIONS

DRILLING SOLUTIONS

SOLID ROUND SOLUTIONS

TOOL HOLDING SOLUTIONS



KYOCERA Precision Tools, Inc.

102 Industrial Park Road
Hendersonville, NC 28792
Customer Service | 800.823.7284 - Option 1
Technical Support | 800.823.7284 - Option 2



Official Website | www.kyoceraprecisiontools.com
Distributor Website | mykpti.kyocera.com
Email | cuttingtools@kyocera.com



©KYOCERA Precision Tools, Inc.
01/17, 10K Printed in the U.S.A